







CHAINSAW

Part#	O.E.M	Application
646-000	Homelite / Jacobsen A97921 Homelite / Jacobsen A70351A	
<p>Clutch Fits Homelite chain saw models: XL-2, Super 2 and XL Mini. (Replaces old style "S" clutch). Size: 2-11/32" OD with a 7/16" - 20 left hand thread.</p>		
646-018	Homelite / Jacobsen 683627/A Homelite / Jacobsen A 98132	
<p>Clutch Fits Homelite chain saw models Super Mini, Super E-Z 150, 150 Automatic and Super XL Mini. Measures: 2-5/8" OD with a 3/8" - 24 left hand thread. (Replaces old style "S" clutch).</p>		
646-026	Homelite / Jacobsen A 98129	
<p>Clutch Fits Homelite chain saw models 240, 245, XL-76. NOTE: will also fit on XL-130, if smaller diameter sprocket is used.. Size: 2-5/8" OD with a 7/16" - 20 left hand thread.</p>		
646-110	McCulloch	
<p>Clutch Fits McCulloch chain saw model: 1010 Measures: 3-1/4" OD (While Quantities Last)</p>		
646-129	Poulan 93919 Weedeater 530069195 Weedeater 530093919	
<p>Clutch Fits Small Poulan / Weedeater chain saw and other equipment. Size: 2-3/16" OD - includes steel washer (While Quantities Last)</p>		
646-117	1125-165-2052	
<p>Clutch Assembly For Stihl chain saw models: 036 / MS360. We recommend that you use a piston stop or air wrench to R&R the clutch properly. Measures: 2.894" OD X 0.390" Thick. 19mm nut attached to this clutch for removal.</p>		

CHAINSAW continued

Part#	O.E.M	Application
646-120 NEW	Stihl 1119-160-2000	
<p>Clutch Assembly For Stihl chain saw model: 038 series. Measures: 2-3/4" OD X 9/16" ID X 5/8" Overall HT.</p>		
646-124	1128-160-2004	
<p>Clutch Assembly For Stihl chain saw models: 044, 046, MS440, MS460, MS341 and MS361. (Washer plate included as shown in picture). We recommend that you use a piston stop or air wrench to R&R the clutch properly. Measures: 2.916" OD X 0.392" Thick. 19mm nut attached to this clutch for removal.</p>		
646-122	1111-160-2003	
<p>Clutch Assembly For Stihl chain saw models: 051 and 075. Measures: 3-5/16" OD.</p>		
646-119	1122-160-2005	
<p>Clutch Assembly For Stihl chain saw models: 064, 066, MS640 and MS660. (Washer plate included as shown in picture). We recommend that you use a piston stop or air wrench to R&R the clutch properly. Measures: 3.140" OD X 0.460" Thick. 19mm nut attached to this clutch for removal.</p>		
646-116	Stihl 1108-160-2002	
<p>Clutch Fits Stihl chain saw model 08S and Cut Quik models TS-350 and TS-360. Measures: 2-19/32" OD X 1/2" bore X 3/16" keyway.</p>		
646-123	Stihl 1125-160-2006	
<p>Clutch Assembly For Stihl concrete / cut quik saw model: TS400. Measures: 2.885" OD</p>		

CENTRIFUGAL - COMET

CENTRIFUGAL (MAX TORQUE)

Part# O.E.M Application

Part# O.E.M Application

255-026

Sprocket Clutch
 Three sintered metal shoes engage at 2000 RPM. Stainless steel garter spring, works clockwise or counter-clockwise, oilite bearing for long life. Works in oil, dirt and water with proper maintenance. (For 2-1/2 thru 8 Hp engine applications) **MADE BY COMET - For outboard mounting only (sprocket away from engine).**
 Number of teeth: 12, Chain Size: #35, Bore: 1", OD: 4-1/4", Keyway: 1/4" (built in). (While Quantities Last)



255-109

Number of teeth: 11
Chain Size: #35
Bore: 5/8"
OD: 4-1/4"
Keyway: 3/16"



255-059

Number of teeth: 10
Chain Size: #40 / #41
Bore: 1"
OD: 4-1/4"
Keyway: 1/4" (built in)
NOTE: Outboard mounting ONLY (sprocket away from engine)
 (While Quantities Last)



255-117

Number of teeth: 10
Chain Size: #40, #41
Bore: 5/8"
OD: 4-1/4"
Keyway: 3/16"



Three sintered metal shoes engage at 2000 RPM. Stainless steel garter spring, works clockwise or counter-clockwise, oilite bearing for long life. Works in oil, dirt and water with proper maintenance. (For 2-1/2 thru 8 Hp engine applications) **MADE BY COMET - For outboard mounting only (sprocket away from engine) All comet clutches are *While Quantities Last***

255-125

Number of teeth: 12
Chain Size: #35
Bore: 3/4"
OD: 4-1/4"
Keyway: 3/16"



255-067

Two sintered metal shoes engage at 2000 RPM. **MADE BY COMET.**
 Fits 2-1/2 thru 8 Hp engines. Non-directional clutch (inboard or outboard).
 Belt Type: A or B, Bore: 5/8", Pulley diameter: 3", OD: 4-1/4", Keyway: 3/16". (While Quantities Last)



255-133

Number of teeth: 10
Chain Size: #40 / #41
Bore: 3/4"
OD: 4-1/4"
Keyway: 3/16"



Six sintered metal shoes engage at 2000 RPM. Stainless steel garter spring, works clockwise or counter-clockwise, oilite bearing for long life. Works in oil, dirt and water with proper maintenance. (For 2-1/2 thru 8 Hp engine applications)

255-083

Belt: A or B section belts
Bore: 7/8"
Pully diameter: 3"
OD: 4-1/4"
Keyway: 5/32"
 (While Quantities Last).



255-307

Belt: A or B section belts
Bore: 5/8"
Pully diameter: 3-1/4"
OD: 4-1/4"
Keyway: 3/16"



255-091

Belt: A or B section belts
Bore: 1"
Pully diameter: 3"
OD: 4-1/4"
Keyway: 1/4"
 (While Quantities Last).



255-315

Belt: A or B section belts
Bore: 3/4"
Pully diameter: 3-1/4"
OD: 4-1/4"
Keyway: 3/16"





Two sintered metal shoes engage at 2000 RPM. **MADE BY COMET.** Fits 2-1/2 thru 8 Hp engines. Non-directional clutch (inboard or outboard).

Six sintered metal shoes engage at 2000 RPM. Stainless steel garter spring, works clockwise or counter-clockwise, oilite bearing for long life. Works in oil, dirt and water with proper maintenance. (For 2-1/2 thru 8 Hp engine applications)

Replacement Sprockets / Bushings / Clutch Keys

Part#	O.E.M	Application	
Part#	Teeth	Chain Size	ID
255-141	11	#35	3/4"
255-158	12	#35	7/8"
255-166	10	#41	3/4'
255-174	10	#41	7/8'



Part#	ID	OD	
255-182	3/4"	7/8"	
255-190	7/8"	1"	
260-265	3/16"	3/4"	

ELECTRIC PTO CLUTCHES

255-711

Ariens# 03601800 / 36018
 Ayp# 145028
 Husqvarna# 532145028
 Simplicity# 1686882 / 1708536
 Simplicity# 5217-2 / 5217-46
 Warner 5217-2
 Warner 5217-46



Size: 1" ID X 3" HT with a 5.375" diameter pulley. Uses a 1/2" belt. Rotation: Counter clockwise. (Made by an O.E.M. supplier). Fits Ariens models: 934005-000101, 934006-000101, 934007-000101, 934008-000101 and 934020-000101.

255-713

Ariens 03090800 / 30908
 Cub Cadet WDC38410
 Grasshopper 388766
 Grasshopper 604182
 Toro / Wheel Horse / 93-3160
 Toro / Wheel Horse / 5215-62
 Warner 5215-62



Uses a 1/2" belt
 (Made by an O.E.M. supplier).
 Measures: 1-1/8" ID X 3-3/4" HT with a 5" diameter double pulley.

ELECTRIC PTO CLUTCHES

Part#	O.E.M	Application
255-710	AYP 108218X AYP 142600 / 137140 Cub Cadet 717-0949 Cub Cadet 717-1434 Cub Cadet 917-0949 Cub Cadet 917-1434 Husqvarna 532108218 Husqvarna 532142600 MTD 717-1434 Warner 5215-51 Warner 5219-64	 <p>Measures: 1" ID keyed hub X 4.175 HT with a 5.304" diameter pulley. Uses 1/2" belt. (Made by an O.E.M. supplier).</p>

255-712	Ariens 03643100 AYP 160889 AYP 36431 Cub Cadet 717-1459 Cub Cadet 917-1459 Dixon 3579 Husqvarna 532 16 08-89 John Deere AM119683 MTD 1772388 / 717-1459 MTD 917-1459 Snapper 53739 / 53740 Snapper 7053740 / 7653740 Swisher 688EC Troy Bilt 1772388 / 9171459 Woods 03643100 Warner 5217-35 Warner 5217-9 / 5217-6	 <p>Measures: 1" ID X 3" HT with a 5.375" diameter pulley. Uses 1/2" or 5/8" belt. Rotation: Counter Clockwise. (Made by an O.E.M. supplier). Fits Ariens models EZR 1540, 1648 and 1742; John Deere model: STX-36; Troy Bilt models: LTX 13095, 13102-13105 and 13123 tractors as well as other makes and models.</p>
----------------	---	--

255-714	AYP 106316X AYP 917063 AYP109550X Bobcat 188018 / 188019 Exmark 1543259 Exmark 543259 Exmark 1551054 Ferris 1521083 Great Dane D18000 Husqvarna 532 91 70-63 Snapper 17063 Snapper 7017063 Warner 5215-14	 <p>Measures: 1" ID X 2-7/8" HT with a 6" diameter pulley. Uses 5/8" belt. (Made by an O.E.M. supplier).</p>
----------------	---	---

ELECTRIC PTO CLUTCHES

ELECTRIC PTO CLUTCHES

Part# O.E.M Application

Part# O.E.M Application

255-715

AYP 102603
 Bobcat 2188151
 Exmark 1030664 / 1631645
 Exmark 1633099 / 633099
 Ferris 1522040
 Husqvarna 102603
 Husqvarna 539 10 26-03
 Kees 102603
 Warner 5218-5



Measures: 1-1/8" ID X 3-1/4" HT with a 6-5/16" diameter pulley. Uses 5/8" belt. (Made by an O.E.M. supplier).

255-719

Ariens 09225400
 Ariens 9225400
 Country Clipper E6247
 Dixon 61516
 Gravely 09225400
 Toro / Wheel Horse 94-6136
 Warner 521810



Size: 1-1/8" ID X 3-1/4" HT with a 5-3/8" diameter pulley. Uses a 1/2" or 5/8" belt(Made by an O.E.M. supplier)

255-716

AYP 326108
 Cub Cadet 138412
 John Deere AM100979
 John Deere AM115090
 John Deere AM116083
 John Deere AM118969
 John Deere AM122969
 John Deere AM123038
 Murray 326108 / 326108MA
 Warner 5215-35
 Warner 5215-55 / 5215-53



Measures: 1" ID X 3-5/8" HT with a 5-3/8" diameter pulley. Uses 1/2" belt. (Made by an O.E.M. supplier).

255-720

Ariens 09232700
 Ariens 9232700
 Gravely 00389900
 Gravely 09232700
 Gravely 09266700
 Great Dane GDA10122
 Wood Mizer P604
 Warner 5218-31
 Warner 5218-94



Measures: 1-1/8" ID X 3-1/4" HT with a 6" diameter pulley. Uses a 1/2" or 5/8" belt (Made by an O.E.M. supplier)

255-717

Ariens 00554300
 Ariens 00574100
 Ariens 55430
 Case C375569
 Grasshopper 388762
 Grasshopper 604180
 Gravely 574100
 Woods 70903 / 73113
 Warner 5218-27



Measures: 1" ID X 3-13/16" HTwith a 4-7/8" diameter double pulley. Uses a 1/2" belt (Made by an O.E.M. supplier)

255-721

Ariens 00574200
 Ariens 09407700
 Grasshopper 388767
 Grasshopper 606242
 Snapper 3-5520
 Snapper 5-8925
 Snapper 7058925
 Woods 73558
 Warner 5218-26
 Warner 5218-58



Size: 1-1/8" ID X 3-3/8" HTwith a 4-7/8" diameter double pulley. Uses a 1/2" belt (Made by an O.E.M. supplier)

255-718

Ariens 03450500
 Dixie Chopper 50300
 Snapper 7-9197
 Snapper 7-9446
 Toro / Wheel Horse 116277
 Warner 5215-88



Measures: 1" ID with a 5-1/4" diameter pulley. Uses a 5/8" belt (Made by an O.E.M. supplier)

255-722

AYP 174367
 Husqvarna 532 17 43-67
 Warner 5215-134



Measures: 1" ID X 3-3/4" HT with a 6" diameter pulley. Uses a 1/2" or 5/8" belt (Made by an O.E.M. supplier)

255-723

Cub Cadet 717-3403
 Cub Cadet 917-3403
 Warner 5218-6



Measures: 1-1/8" ID X 3" HT with a 6" diameter pulley. Uses a 5/8" belt (Made by an O.E.M. supplier)

ELECTRIC PTO CLUTCHES

ELECTRIC PTO CLUTCHES

Part# O.E.M Application

255-724

Cub Cadet 717-3446
Cub Cadet 917-3446
MTD 717-3446
MTD 917-3446
Warner 5218-29

Measures: 1" ID X 3-1/2" HT
with a 6" diameter pulley.
Uses a 5/8" belt (Made by an O.E.M. supplier)



255-359

AYP 124648X
AYP 150283 / 140923
AYP 174509 / 170056
Cub Cadet 717-3375
Cub Cadet 717-3384
Cub Cadet 917-3375
Cub Cadet 917-3384
Husqvarna 532106228
Husqvarna 532140923
Husqvarna 532144509
Husqvarna 532170056
Warner 5210-60
Warner 5215-73

Size: 1.11" ID X 4.825" HT with a 5.31" diameter pulley.
Uses a 1/2" belt. Fits Husqvarna models: GTH2250 A,
GTH2550 B, GTH2550 XP A and GTH2550 XP B.
(Made by an O.E.M. supplier)

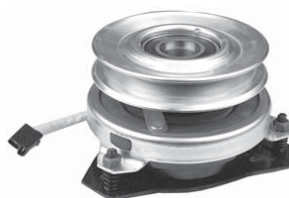

255-727

Encore 523370 / 523025
Warner 5218-17

Size: 1-1/8" ID X 3-1/2" HT
with a 6" diameter pulley.
Uses a 5/8" belt.
(Made by an O.E.M. supplier).
Replaces WARNER# 5218-17



255-725

MTD 717-1708
MTD 917-1708
Snapper 14022
Snapper 74022
Warner 5215-129

Measures: 1" ID X 3-1/2" HT
with a 5-3/8" diameter pulley.
Uses a 1/2" belt. (Made by an O.E.M. supplier).



255-730

Ariens 00191700
Gravely 00191700
Warner 5219-45

Size: 1" ID with a 6" diameter pulley.
Uses a 5/8" belt. (Made by an O.E.M. supplier).



Part# O.E.M Application

255-12230

Cub Cadet 717-3384 / 717-3389
Cub Cadet 917-3384 / 917-3389
Mtd 717-3389 / 917-3389
Warner 5210-30
Warner 5215-68

Fits Cub Cadet models: 1440,
1641, 1782, 2182, Z42, Z48, Z48L,
Z54, Z54L, 2160, 2165 and 4815 serial numbers
851,001 and above. Counter Clockwise Rotation.
Size: 1" ID X 6" OD pulley X 4.825" HT; 5/8" belt



255-726

MTD 717-1709
MTD 917-1709
Warner 5215-130

Measures: 1" ID X 4" HT with a
5-3/8" diameter pulley.
Uses a 1/2" belt.
(Made by an O.E.M. supplier).



255-728

Cub Cadet 917-3497
Jacobsen 990947
MTD 717-3497
MTD 917-0983
Simplicity 1703816
Snapper 1-6343
Toro / Wheel Horse 99-8012
Warner 52-1033
Warner 52-1559

Measures: 1" ID X 3-1/2" HT with a 5.345" diameter pulley.
Rotation: Counter clockwise. Uses a 1/2" belt.
(Made by an O.E.M. supplier).



255-731

Bobcat 2721337
Bunton 2721337
Excel 787366
Exmark 1030501 / 1030665
Exmark 1631732 / 1641300
Grasshopper 388740
Toro / Wheel Horse 1030501
Warner 5218-213
Warner 5218-65

Measures: 1-1/8" ID with a 6-3/8" diameter pulley.
Uses a 5/8" belt. (Made by an O.E.M. supplier).
Fits Exmark models 1600,000 & higher. Fits Bad Boy 070-
5035-00, Exmark/Toro 103-0501, Auburn 180265, Bad
Boy 070-5035-00, Bobcat 2721337, Grasshopper 388740,
Hustler 787366, Toro 103-0501. Midmounts Excel 787366.
For 25 Hp engines. Fits Exmark Lazer Z series #160,000
and higher and MS200F; for 25 Hp engines.



ELECTRIC PTO CLUTCHES

ELECTRIC PTO CLUTCHES

Part# O.E.M Application

Part# O.E.M Application

255-732
 Bobcat 2722016
 Bunton 2722016
 Warner 5219-14
 Measures: 1-1/8" ID with a 6" diameter pulley. Uses a 5/8" belt. (Made by an O.E.M. supplier).



255-736
 Exmark 103-0665
 Exmark 164-1300
 Exmark 163-1732
 Ferris 1521145
 Scag 461395
 Scag 481530
 Warner 5218-65



255-733
 Cub Cadet 717-04163
 Cub Cadet 917-04163
 MTD 717-04163A
 MTD 917-04163A
 Warner 5217-32
 Warner 5217-43
 Measures: 1" ID with a 5.923" diameter pulley; 4" HT. Uses 1/2" or 5/8" belt. Fits Cub Cadet models: LT1040, LT1042, LT1045, LT1046 and LT1050. Counter clockwise rotation. (Made by an O.E.M. supplier).



Size: 1-1/8" ID X 2-3/4" HT with a 6" diameter pulley (Made by an O.E.M. supplier) Fits models 1600,000 and higher. Fits Bad Boy 070-5035-00, Exmark/Toro 103-0501, Auburn 180265, Bobcat 2721337, Grasshopper 388740, Midmounts Excel 787366. 25 Hp engines.

255-734
 Cub Cadet 717-0417A
 Cub Cadet 717-041ZA
 Cub Cadet 917-0417
 Cub Cadet 917-04174A
 Cub Cadet 917-0417A
 MTD 717-0417 / 717-04174A
 MTD 717-0417A / 917-0417
 MTD 917-04174A / 917-0417A
 Troy Bilt 9170417A
 Warner 5219-51
 Warner 5219-79
 Measures: 1" ID with a 6" diameter pulley; 4-1/4" HT. Uses a 5/8" belt. Counter Clockwise Rotation. Fits Cub Cadet models: LT1042, LT1045, LT1046, LT1050, L1046, L1050, SLT1550 and SLT1554. (Made by an O.E.M. supplier).



255-737
 Exmark 1030690
 Exmark 1653048
 Exmark 1653292
 Exmark 653292
 Warner 5218-80
 Warner 5218-80C
 Measure: 1" ID X 3-1/4" HT with a 7-3/8" diameter pulley
 Uses a 5/8" belt (Made by an O.E.M. supplier)



255-735
 Exmark 103-0661
 Exmark 103-0662
 Scag 03-0661
 Scag 461397
 Warner 52-1876
 Measures: 1" ID X 3-3/8" HT with a 6-3/8" diameter pulley. Uses a 5/8" belt (Made by an O.E.M. supplier)



255-738
 Gravely 09232700
 Gravely 9266700
 Great Dane GDA10122
 Wood Mizer P604
 Warner 5218-94
 Measure: 1" ID X 3-1/4" HT with a 6" diameter pulley. Uses a 1/2 or 5/8" belt. (Made by an O.E.M. supplier). Fits Exmark model: Lazer Z Hp serial numbers 260,000 and higher. Replaces WARNER# 5218-80 / 5218-80-C. Similar to our 255-787 - our 225-737 has a 7-3/8" OD Pulley compared to our 255-787 with a 7-11/32" OD Pulley.



255-11072
 Cub Cadet 01002108P
 Warner 5218-14
 Measures: 1" ID with a 6" diameter pulley. Uses a 5/8" belt. Fits TANK models, also fits Lesco. (Made by an O.E.M. supplier)









255-739
 Cub Cadet 717-04080
 Cub Cadet 917-04080
 MTD 717-04080
 MTD 717-1709
 MTD 917-04080
 MTD 917-1709
 Warner 5215-142
 Measures: 1" ID with a 6" diameter pulley. Uses a 5/8" belt. (Made by an O.E.M. supplier)



ELECTRIC PTO CLUTCHES

ELECTRIC PTO CLUTCHES

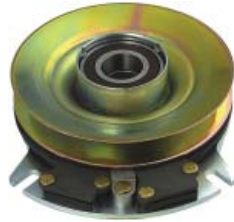
Part#	O.E.M	Application
255-11074		
	Toro / Wheel Horse 105-1671 Toro / Wheel Horse 94-4632 Warner 5218-33	
	Measures: 1-1/8" ID with a 4-7/8" diameter pulley. Uses a 5/8" belt. Fits A320 - Z325. (Made by an O.E.M. supplier)	
255-787		
	Exmark 103-0690 Exmark 165-3048 Toro / Wheel Horse 105-3630 Warner 5218-201 Warner 5218-215 Warner 5218-44	
	Size: 1" ID, Height: 3-1/4", Pulley diameter: 7.345", Uses belt width: 5/8". Measures: 1" ID X 3-1/4" HT with a 7.345" diameter pulley. Uses 5/8" belt. (Made by an O.E.M. supplier). Replaces WARNER# 5218-44, 5218-201 and 5218-215. Found on Exmark models Lazer HP and Lazer; for 17 Hp Kawasaki engines; also replaces Toro# 105-3630. Similar to our 255-737 but with slightly smaller pulley OD.	
255-701		
	Cub Cadet 717-3385A Cub Cadet 917-3385A Mtd 717-3385A Mtd 917-3385A Warner 5217-14 Warner 5217-42	
	Measures: 1" ID X 3-1/2" HT with a 5.345" diameter pulley. Uses a A / B belts. Counter Clockwise rotation (Made by an O.E.M. supplier). Fits Cub Cadet 2000 series; models: 2130, 2135, 2146, 2150, 2155, 21665, 38" & 42" decks.	
255-702		
	Fits Exmark Warner# 5218-54	
	Size: 1-1/8" ID X 3-5/16" HT with a 7.385" diameter pulley. Uses a 5/8" belts. Counter Clockwise rotation (Made by an O.E.M. supplier) Fits Exmark mowers with larger engines and crankshafts. Note: Similar to our 255-737 but with a larger 1-1/8" bore.	
255-703		
	Exmark 103-0281 Exmark 1031364 Warner 5218-73	
	Measures: 1-1/8" ID with a 6.313" diameter pulley. Uses a 5/8" belt. (Made by an O.E.M. supplier)	

Part#	O.E.M	Application
255-704		
	Exmark 1-603539 Exmark 603539 / 1-611223 Ferris 1521823 Scag 461074 Scag 481633 / 48786 Simplicity 21823 Snapper 2-9678 Warner 5215-13	
	Measures: 1" ID X 3-1/2" HT with a 6" diameter pulley. Uses a A / B belts. Clockwise rotation (Made by an O.E.M. supplier) Fits Exmark Turf Tracer Hydro models, also fits Scag SSZ and STHM; and Simplicity models Hw1436 Pacer Hydro walk behinds with 36" cut decks; for 21 Hp engines.	
255-705		
	Cub Cadet 717-3044 Hustler 781039 Hustler 781039K Warner 5218-110 Warner 5218-219	
	Size: 1-1/8" ID, Height: 3-5/16", Pulley diameter: 6-1/4", Uses both A/B belts, Rotation: Counter Clockwise. Fits Hustler models: Super Z, 52", 60" and 72" decks; also found on Grasshopper model 223.	
255-706		
	Exmark 103-3246 Exmark 103-6579 Exmark 109-7665 Warner 5218-202 Warner 5218-99	
	Size: 1-1/8" ID X 3-5/16" HT with a 7-11/32" diameter pulley. Uses a 5/8" belt. Clockwise rotation (Made by an O.E.M. supplier). Fits Exmark Lazer HP / Z models; for 27 and 30 HP Kohler engines.	
255-06272		
	Murray 69046 Murray 7601023 Scotts 690461 Scotts 7601023 Warner 5218-32 Warner 5218-35	
	Measures: 1" ID X 3-1/8" HT with a 6" diameter pulley. Uses a A / B belt. (Made by an O.E.M. supplier) Fits Murray - Scotts models. Has a built in 1/4" keyway. NOTE: IF THE CUSTOMER HAS THE SHORT D DRIVE IN HIS OLD CLUTCH THEY WILL NEED TO DRIVE IT OUT AND REUSE IT TO KEEP THE NEW CLUTCH FROM BURNING UP.	

ELECTRIC PTO CLUTCHES

TRIMMER CLUTCHES

Part# O.E.M Application

255-740

Cub Cadet 717-1774C
Cub Cadet 917-1774C
MTD 717-1774C
MTD 917-1774B
MTD 917-1774C
Warner 5219-25



Size: 1" ID, Height: 4-1/4", Pulley diameter: 5-15/16", Uses 5/8" belt. Rotation: Counter Clockwise. Fits Cub Cadet, MTD and Toro/Home Depot models. Fits Cub Cadet models: RZT54, GT1554, SLT1554 and LT1024; also fits 50" Toro/Home Depot and 54"; 800 series mowers.

255-12899
NEW

Cub Cadet 917-04180
Warner 5219-52



Size: 1-1/8" ID, Pulley diameter: 6", Uses 5/8" belt. Cub Cadet models: GT2500 series and LT2042, GT2544, GT2550 and GT2554.

255-12981
NEW

Exmark 1033245
Warner 5218-100
Warner 5218-228
Warner 5218-243



Size: 1" ID, Pulley diameter: 7-1/8"
Fits Exmark models with 20 and 23 Hp Kohler engines, Uses 5/8" belt. Replaces Warner 5218-243 with pigtail, 5218-228 without pigtail & Warner# 5218-100

255-800
NEW

Warner 5218-251-001



Electric PTO Clutch
Pigtail harness.
Replaces Warner# 5218-251-001.
Does not have a diode like Hustler & Grasshopper use.
Fits our 255-787 as well as many others.

Quick Tip -
Replacing Electric PTO Clutches

- Use Grade 5 or Grade 8 bolt only!
 - Minimum torque:**
 - 7/16" UNF bolt is 50 foot pounds / 67 Nm
 - 3/8" UNF bolt is 31 foot pounds / 42 Nm
 - M10 X 1.5 bolt is 35 foot pounds / 48 Nm
- WARNING - Anything less than required mounting torque will result in clutch failure.**

Part# O.E.M Application

646-125 Echo 175009-05733
John Deere AM115909



Clutch
Fits Echo Trimmer models SRM300, SRM300AE and SRM3000 and John Deere Trimmer model 30S.
Size: 2-3/8" OD with (2) 5/16" ID mounting holes.
(While Quantities Last)

646-126 Echo 175009-05532
Green Machine 190025
Green Machine 190111
Hoffco 211325S
John Deere AM115397
Red Max 1100-51113
Red Max 1130-00602



Clutch
Fits Echo Trimmer models SRM250, SRM2000, SRM2200, SRM2500, SRM2501, SRM2502, SRM2510, SRM2510S.
Green Machine models 1900, 2400M, 2500, 2800, 2810, 3000M, 3000SS, 3010M, 4000M. Hoffco models 95 - JP30F300, 96 - JP220F and 95/96 - SE301F.
Red Max models Bt2000, BC2001DL and BC2300DL.
Size: 2" OD with (2) 5/16" ID mounting holes.

646-142 Homelite / Jacobsen 130182078
Homelite / Jacobsen 9806329
Kawasaki 13018-2078
Kawasaki 13081-2194

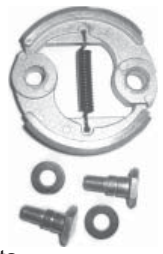

Clutch
Fits Homelite (with Kawasaki engine) Trimmer / Brushcutter model HK-33, also fits Kawasaki models TD-40, TD-43 and TD-48.

646-270 Maruyama 264886



Clutch
Fits Maruyama Trimmer models MC2300, MC2610, MC3210, BC2300, BC2600 and Bc3200.
Also fits Stihl Trimmer model: FS108.
(While Quantities Last)

646-183 Ryan 181598
Ryobi 181598
Stihl 4130-160-2000



Clutch
Fits Ryan / Ryobi Trimmer models with clutch.
NOTE: For use with our 646-184 Clutch Drum - see our "TRIMMER PARTS" section for more information.

