

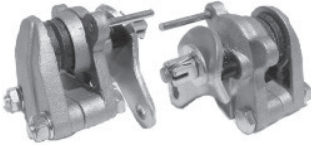





BRAKE PARTS

Part#	O.E.M	Application
260-109	Manco# 3759 Universal Application	
<p>Disc Brake Assembly Found on many Lawnmowers, can be used on Mini-Bikes, Go-Carts & Snowmobiles. NOTE: Front and Back images shown - (1) assembly only</p>		
260-125	Flat-end type Universal	
<p>Brake Pads Replacement brake pads found in our 260-109 disc brake assembly. Large pad measures: 1-1/16" dia. X 1/2" thick, Small pad measures: 1-1/16" dia. X 9/32" thick. (Priced and sold in pairs)</p>		
260-610	Murray# 776938 Comet# 218198C	
<p>Brake Pads Replacement brake pads found on our 260-308 Manco Disc Brake Caliper. Fits on MURRAY Go-Carts Pad measure: 1-5/8" OD X 1 1/32" Thick. (D-shape) (Priced and sold in pairs) (While Quantities Last)</p>		
260-117	Round type Universal	
<p>Brake Pads Replacement brake pads Found on many disc brake assemblies. Measurements are the same as our 260-125 above. (Priced and sold in pairs)</p>		
260-141	Universal	
<p>Brake Drum 4" steel brake drum has the popular industrial pattern and universal mounting holes 5/16" and 3/8". Measures: 2" ID X 3-31/32" OD X 1" HT</p>		
260-135	Monaco# 1492	
<p>Brake Band and Pin Use with our 260-141 Brake Drum assembly. Fits Manco. Size: 4" diameter.</p>		
260-190	Fox and Rupp Universal	
<p>Brake Cable Fits FOX and RUPP front wheels. Inner cable measures: 34". Outer casing measures: 30". Comes complete with U-clamp and spring.</p>		
260-208	Universal	
<p>Brake Cable For use on Mini-Bikes, Go-Carts etc. equipped with disc brakes. Comes complete with spring and U-Clamp. Cable measures 56" in length.</p>		





BRAKE PARTS continued

Part#	O.E.M	Application
260-216	Universal	
<p>Brake Cable This is a universal brake cable which has a 65" inner cable and a 60" outer casing. Heavy duty long wear with a barrel on one end.</p>		
CENTRIFUGAL CLUTCH		
255-095	LD45-5L	
<p>Number of teeth: 12, Chain Size: #35, Bore: 3/4", Keyway: 3/16".</p>		
255-096	LD45-4L	
<p>Number of teeth: 10, Chain Size: #41, Bore: 3/4", Keyway: 3/16".</p>		
<p>HILLIARD'S Extreme Duty Go Kart Clutch for 3/4" crankshafts - Hilliard's new patent pending Extreme Duty centrifugal clutch can handle higher temperatures to offer longer clutch life. - Bi-directional, can run clockwise & counter clockwise. - Dissipates heat better, extending clutch life. - Clutch is easily tuned for your specific need. - Quick change spring and sprocket design. - No special tools needed. - Built in internal keyway. - Must use crankshaft bolt.</p>		
255-098	8444-47-023	
<p>Hilliard clutch drive sprocket 1-27/32" OD, 12 teeth, chain 35. For LD4S-4 & LD4S-41 series Go-Kart clutches. Fits our 255-095 clutch.</p>		
255-097	8444-47-007-B	
<p>Hilliard clutch drive sprocket 1-27/32" OD, 10 teeth, chain 40/41. For LD4S-4 & LD4S-41 series Go-Kart clutches. Fits our 255-096 clutch.</p>		
255-099	8444-15-003-B	
<p>Hilliard clutch bushing 3/4" bore, 3/16" keyway. Used with our 255-095 & 255-096.</p>		
<p>For more Go-Cart / Mini Bike Clutches and Comet Torque Converter see our "CLUTCHES" section (pages 18-01 thru 18-09)</p> 		

CLUTCH COLLARS





Part#	Application
255-208 MTD# 711-0169 Size: 5/8" ID X 1" OD X 9/16" HT (Priced & sold as a pair)	
255-216 Universal Size: 3/4" ID X 1-1/4" OD X 1/2" HT (Priced individually)	

DRIVE SPROCKETS

240-168 Chain size: #43, Teeth: 9, Bore: 1/2", OD: 1", Keyway: 3/32"	
260-083 Chain size: #35, Teeth: 12, Bore: 5/8", OD: 1-5/8", Keyway: 3/16" (While Quantities Last)	
260-047 Chain size: #35, Teeth: 16, Bore: 5/8", OD: 2-1/8", Keyway: 3/16"	
260-091 Chain size: #41, Teeth: 10, Bore: 5/8", OD: 1-5/8", Keyway: 3/16"	

For other Drive Sprockets - see our "DRIVE PARTS" section 22

SPROCKETS - STEEL PLATE

260-042 UNIVERSAL Measures: 2-1/8" ID X 7-3/8" OD, 8 bolt holes, 4 bolt pattern with 2" and 2-1/2" centre to centre. Teeth #: 60, Chain size: #35 (While Quantities Last)	
260-059 Measures: 2" ID X 8-3/4" OD, 4 bolt hole industrial pattern with mounting holes 2" apart. Teeth #: 72, Chain size: #35	
260-075 Measures: 2-1/8" ID X 8-7/8" OD 4 bolt pattern with (4) 5/16" and (4) 3/8" bolt holes, 2" and 2-1/2" centre to centre Teeth #: 54, Chain size: #41	
260-052 Measures: 2-1/8" ID X 9-13/16" OD, 4 bolt pattern with (4) 5/16" and (4) 3/8" bolt holes, 2" and 2-1/2" centre to centre Teeth #: 60, Chain size: #41	

ROLLER CHAIN - 10 FT

Part#	Chain Size	Dimension
250-000	#25	1/4" X 1/8"
250-001	#35	3/8" X 3/16"
250-027	#41 (std. pin dia)	1/2" X 1/4"
250-010	#420 (larger pin dia)	1/2" X 1/4"
250-019	#40	1/2" X 5/16"
250-011	#42	1/2" X 3/16"
250-035	#43 / #65	1/2" X 1/8"
250-043	#50	5/8" X 3/8"
250-050	#60	3/4" X 1/2"



CONNECTING LINKS

Part#	Chain Size	Dimension
250-187	#25	1/4" X 1/8"
250-084	#35	3/8" X 3/16"
250-092	#40	1/2" X 5/16"
250-100	#41	1/2" X 1/4"
250-192	#42	1/2" X 3/16"
250-118	#43 / #65	1/2" X 1/8"
250-126	#50	5/8" X 3/8"
250-134	#60	3/4" X 1/2"
250-193	#420	1/2" X 1/4"
250-182	#428	1/2" X 5/16"



OFFSET LINKS

Part#	Chain Size	Dimension
250-125	#25	1/4" X 1/8"
250-142	#35	3/8" X 3/16"
250-159	#40	1/2" X 5/16"
250-167	#41	1/2" X 1/4"
250-179	#42	1/2" X 3/16"
250-175	#43 / #65	1/2" X 1/8"
250-183	#50	5/8" X 3/8"
250-191	#60	3/4" X 1/2"
250-181	#420	1/2" X 1/4"
250-194	#428	1/2" X 5/16"

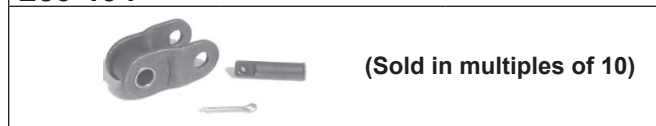







KEY STOCK

Part#	OEM#	Size	Length
260-000	Key Stock	3/16"	(Sold in 12" Lengths)
260-018	Key Stock	1/4"	(Sold in 12" Lengths)
260-026	Key Stock	5/16"	(Sold in 12" Lengths)
260-034	Key Stock	3/8"	(Sold in 12" Lengths)





TWIST GRIP SET & CABLES

260-224	Twist Grip Set	
Fits 7/8" tube handle. Deluxe throttle controls that come complete with twist grip and dummy grip. (Metal)		
260-228	Twist Grip Set	
Fits 1" tube handle. Deluxe throttle controls that come complete with twist grip and dummy grip. (Metal)		
260-220	Twist Grip ferrule.	
This Ferrule is used on many twist grips to hold the housing in place.		
260-265	Clutch Key	
Size: 3/16" X 3/4" Long		
260-166	Throttle Cable	
Inner wire: 56" X Outer conduit: 48" X Condit size: 3/16". Ball at one end / barrel at the other.		
260-174	Throttle Cable	
Inner wire: 65" X Outer conduit: 60" X Condit size: 3/16". Ball at one end / barrel at the other.		





TWIST GRIP SET & CABLES

Part#	Application
260-182	Throttle Cable
 <p>Inner wire: 100" X Outer conduit: 90" X Condit size: 3/16". Ball at one end / barrel at the other.</p>	







KILL BUTTON / KILL SWITCH

430-070	Kill Button	
Comes complete with 42" of wire. Will fit all 7/8" and 1" tube handles. Can be used on Lawn & Garden equipment as well as Mini-Bikes, Go-Carts etc.		
430-066	Deluxe Kill Switch	
Used on Go-Carts and ATV's. Comes with a 48" lead wire and (2) metal clamps with screw.		

TORQUE CONVERTER BELTS

Part#	O.E.M	Application
875-200393	Comet# 200393 Comet# 200393A Manco# 1154	
Cogged belt Fits Torque Converters found on Mini-Bikes, Go-Carts etc. Measures: 5/8" W X 27-3/8" L		
875-203589	Comet# 203578A Comet# 203589A Manco# 5959	
Cogged belt Fits Torque Converters found on Mini-Bikes, Go-Carts etc. Measures: 3/4" W X 27-3/8" L		
875-203590	Comet# 203590A Manco# 6959 Manco# 9655	
Torque Converter Belt. Fits Torque Converters found on Mini-Bikes, Go-Carts etc. Found on 30 series, Asymmetric systems. Measures: 3/4" W X 28.32" L		
875-203580	Comet# 203580A Manco# 4292	
Torque Convert Belt. Fits Torque Converters found on Mini-Bikes, Go-Carts etc. Measures: 3/4" W X 29.28" L		

TORQUE CONVERTER BELTS

Part#	O.E.M	Application
875-203592	Comet# 203592	
<p>Torque Converter Belt Fits Torque Converters found on Mini-Bikes, Go-Carts etc. Found on 30 series, Asymmetric systems. Measures: 3/4" W X 30.25" L</p>		
875-203581	Comet# 203581A	
<p>Torque Convert Belt. Fits Torque Converters found on Mini-Bikes, Go-Carts etc. Measures: 3/4" W X 30.25" L</p>		
875-203582	Comet# 203582	
<p>Torque Convert Belt Also fits Bristers rear mount. Fits Torque Converters found on Mini-Bikes, Go-Carts etc. Measures: 3/4" W X 31.23" L</p>		
875-203583	Comet# 203583A	
<p>Torque Convert Belt Also replaces G776 Belt S20 884-95F, fits Carter Bros. Fits Torque Converters found on Mini-Bikes, Go-Carts etc. Measures: 3/4" W X 31.23" L</p>		
875-203593	Comet# 203593A	
<p>Torque Converter Belt. Fits Torque Converters found on Mini-Bikes, Go-Carts etc. Found on 30 series, Asymmetric systems. Measures: 3/4" W X 31.23" L</p>		
875-203584	Comet# 203584A Comet# 884100	
<p>Torque Convert Belt Fits Torque Converters found on Mini-Bikes, Go-Carts etc. Measures: 3/4" W X 33.187" L</p>		
875-203585	Comet# 203585A	
<p>Torque Convert Belt Fits 340 series clutches. Fits Torque Converters found on Mini-Bikes, Go-Carts etc. Measures: 3/4" W X 33.78" L</p>		

TORQUE CONVERTER BELTS

Part#	O.E.M	Application
875-203586	Comet# 203586A	
<p>Torque Convert Belt Fits 340 series clutches. Fits Torque Converters found on Mini-Bikes, Go-Carts etc. Measures: 3/4" W X 35.14" L</p>		
875-368	Comet# 203597 Comet# 203597A Murray# 203597 Murray# 37X125 Murray# 37X98	
<p>Cogged belt Fits Torque Converters found on Mini-Bikes, Go-Carts etc. Replaces Comet# 203597A. Fits Comet 30 series, Asymmetric systems. Found on many Murray Go-Karts. Size: 3/4" W X 35-3/8" L</p>		
875-203785	Comet# 203785A Manco# 12346	
<p>Torque Convert Belt 40 Series. Fits Comet, Manco and Carter Bros. G721. Fits Torque Converters found on Mini-Bikes, Go-Carts etc. Measures: 7/8" W X 33.87" L</p>		

STEERING WHEEL

285-482	Universal	
<p>Steering Wheel for Go-Carts. Size: 10" diameter steering wheel with a 1/2" centre hole, (3) 1/4" mounting holes, 1-3/8" centre to centre.</p>		(While Quantities Last)

ATV PARK PLUG

690-400	NGK# C7HSA	
<p>Spark Plug Used on many Chinese built ATV's. Replacement for NHSP LD Torch A7RTC 044 & 041. Note: Priced and Sold Individually</p>		