





AYP

Part#	O.E.M	Application
<b>105-027</b>	137348 Husqvarna 532-137348 Weedeater 917120330X	
<p><b>Muffler</b> Fits selected AYP / Husqvarna / Poulan tractors. Models 270450, 270451, 271150, 271470, 271471, 2H4B6B, 2H4B6C, 7124A89, 917.252500, AB13107B, AK12542C, AK12542B and AK125H42C. Size: 1" pipe diameter, 3-3/4" W X 8-1/2" L X 4" HT</p>		

BRIGGS & STRATTON







<b>105-239</b>	392811 295905 493288	
<p><b>Muffler</b> For 2, 3 and 4 Hp engines. Super low tone, 1/2" pipe thread Fits models 60000 and 80000. Measures: 4-3/4" L X (3-1/8" X 2-5/8") OD (Includes our 110-122 deflector)</p>		

<b>105-080</b>	299106	
<p><b>Muffler</b> 1/2" pipe thread, economy style For use in tight spaces. Fits models 60100, 82500, 92599, 92900, 93500. Measures: 1.-3/4" L X 2-1/2" OD X 1-21/32" HT</p>		

<b>105-221</b>	394569 / 394569S 391435 / 298830 John Deere AM35015	
<p><b>Muffler</b> For 3, 3-1/2 and 4 Hp engines. 1/2" pipe thread, painted gray finish. Fits models 90700, 92500, 93902, 95902, 96502, 96902, 98902, 110700, 133702, 10A902 and 9D902.. Size: 2-3/4" L X 3" OD (Replaces old# 105-056)</p>		

<b>105-007</b>	89966 Clinton 170-159-500 John Deere AM34980 Tecumseh 30874 Tecumseh 30911	
<p><b>Muffler</b> For 2, 2-1/2, 3, 3-1/2 and 4 Hp engines. 1/2" pipe thread, heavy gauge steel OEM style, painted gray finish with brass welds. Fits models 60000, 80000, 92000 and 110900. Measures: 4-3/4" L X 1-1/2" OD</p>		

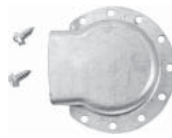
BRIGGS & STRATTON

Part#	O.E.M	Application
<b>105-106</b>	294599 294599S Tecumseh 32985	
<p><b>Muffler</b> For 4 thru 8 Hp engines. 3/4" pipe thread, Fits models 140700, 141200, 146400, 146700, 170400, 170700, 190400 and 190700. Measures: 6-1/4" L X 2-3/8" OD (Uses our 110-015 locknut)</p>		
<b>105-163</b>	393010 393010S 390249 John Deere PT4336	
<p><b>Muffler</b> For 5, 7 and 8 Hp horizontal engines. 3/4" pipe thread, Super low tone. Fits models 100200, 135200, 170400, 171400, 190400, 190700, 194400, 195400 and 195700. Measures: 5-3/8" L X 3-1/8" OD</p>		
<b>110-007</b>	91811 / 220859 John Deere M47824	
<p><b>Muffler Lock Nuts</b> Fits 1/2" pipe thread. For our 105-239, 105-080, 105-221, 105-007 mufflers. (Sold in multiples of 5)</p>		
<b>110-015</b>	91242 261409 / 690453 John Deere HE3310053	
<p><b>Muffler Lock Nuts</b> Fits 3/4" pipe thread. For our 105-106 &amp; 105-163 mufflers. (Sold in multiples of 5)</p>		
<b>110-130</b>	393757 John Deere PT5035	
<p><b>Muffler Deflector</b> Fits our 105-155 &amp; 105-163 mufflers. Measures: 2-7/8" OD X 5/8" HT</p>		
<b>105-061</b>	494585 393615	
<p><b>Muffler</b> For 5 Hp vertical shaft engines. Bolt on style. Comes complete with bolts, lock and gasket. NOTE: Top &amp; Bottom pictures (1) muffler only</p>		
<b>485-924</b>	270918 272309 / 692237	
<p><b>Exhaust Gasket</b> Fits models 130200, 133700, 193700, 196400 and 197400. (Use with our 105-061, 105-155 and 105-148 mufflers) (Sold in multiples of 10)</p>		

BRIGGS & STRATTON

BRIGGS & STRATTON

Part#	O.E.M	Application
-------	-------	-------------

Part#	O.E.M	Application
-------	-------	-------------

**105-155** 391313  
692304  
John Deere  
AM100310



**Muffler**  
For 4 thru 8 Hp engines.  
Gasket & Hardware included, Super low tone  
Fits models 100000, 130000, 170000 and 190000. C to C of bolt holes - 1-9/16"  
Size: 4-1/2" L X 4-1/4" W 2-3/4" HT  
NOTE: Top and Bottom pictures (1) muffler only

**485-923** 270774  
272252  
691880



**Exhaust Gasket**  
Fits models 106900, 110900, 111900 and 10A-900 thru 10C900. (Use with our 105-023 muffler)  
(Sold in multiples of 10)

**110-130** 393757  
John Deere PT5035

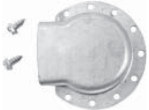

**Muffler Deflector**  
Fits our 105-155 and 105-163 mufflers. Measures: 2-7/8" OD X 5/8" HT

**105-353** 490547  
496106



**Muffler**  
For 4-1/2 and 5 Hp Quantum engines.  
Bolt on style, Super low tone.  
Includes bolts, gasket keeper and spacer.  
NOTE: Exhaust gasket 485-924 can be made to fit our 105-353.

**105-288** 691874 / 491413  
394170 / 394180  
John Deere AM108033



**Muffler**  
For 10 thru 12-1/2 Hp vertical and horizontal engines. Bolt on style, Super low tone. Includes: bolts, lock, mount gasket and deflector.  
Fits models 220400, 220700, 221400, 251400, 251700, 252400, 252700, 255400 and 282707.  
Size: 5" L X 4-1/2" W X 3-1/2" HT Centre to Centre of bolt holes: 1-7/8" NOTE: Top and Bottom pictures (1) muffler only

**105-148** 297274  
297506 / 393615  
493936 / 494585



**Muffler**  
For 4 and 5 Hp engines.  
Bolt on style, painted black.  
Fits models 100200, 100900, 130200, 130900, 133200, 133700, 134200, 135700, 136200 & 137200.  
Size: 4" L X 3-5/8" W X 1-1/2" HT  
(Use with our 110-114 deflector)

**485-920** 270917  
272293  
692236



**Exhaust Gasket**  
For 8 and 11 Hp engines. Fits models 280000 and 281000. (Use with our 105-288 muffler) (Sold in multiples of 10)

**485-924** 270918  
272309  
692237



**Exhaust Gasket**  
Fits models 130200, 133700, 193700, 196400 and 197400. (Use with our 105-061, 105-155 and 105-148 mufflers)  
(Sold in multiples of 10)

**110-148** 393761  
John Deere PT9009



**Muffler Deflector**  
Fits our 105-288 mufflers. Measures: 3-5/16" OD X 5/8" HT.

**105-189** 299629  
Snapper 1-8198



**Muffler**  
For 8 Hp engines on Snapper Riders.  
Use with our 110-205 muffler tube.  
Fits models 170432, 170451, 190702 and 190707.  
Measures: 5" L X 3-3/8" W X 2-1/8" HT  
NOTE: Front and back images shown

**105-023** 391492  
394644 / 692307  
John Deere AM200187



**Muffler**  
For 3 thru 4 Hp Max vertical engines. Bolt on style, Super low tone.  
Includes: bolts, gasket keeper and spacer. Fits models 90700, 91700, 93900, 10A900, 10C900, 110900, 111000, 111900 & 114700.  
Measures: 8" L X 3-3/4" W X 1-3/4" HT Centre to Centre of bolt holes: 1-3/16"

**105-254** 299477  
391569 / 391569S  
Tecumseh 50989



**Muffler**  
For 8 thru 16 Hp engines.  
Fits MTD 600 series Riders.  
1" pipe thread, painted black.  
Models 251412, 251416, 254422, 254427 and 283702.  
Measures: 4-1/2" pipe length X 4-1/2" muffler OD (Use with our 110-023 lock nut and 110-148 deflector) For longer version - see our 105-256 muffler

BRIGGS & STRATTON

CUB CADET

Part#	O.E.M	Application
-------	-------	-------------

<b>105-256</b>	393232 393232S AYP 3483 Murray 23343 Murray 23483	
<p><b>Muffler</b> For 11 and 16 Hp cast iron engines. 1" pipe thread, painted silver. Model 326400. Measures: 8" pipe length X 4-1/2" muffler OD (Use with our 110-023 lock nut and 110-148 deflector) For shorter version - see our 105-254 muffler</p>		

<b>110-023</b>	91310 / 261564 261409 / 691808 Gravely 10866 / 21375700 Kohler AC-1536 Tecumseh 650590	
<p><b>Muffler Lock Nuts</b> For our 105-254, 105-256 mufflers. All muffler lock washers are (Sold in multiples of 5)</p>		

<b>110-114</b>	393750 221488 John Deere PT5282	
<p><b>Muffler Deflector</b> For our 105-148 muffler.</p>		

<b>110-106</b>	393755 221794	
<p><b>Muffler Deflector</b> For our 105-080 and our old #105-056 mufflers.</p>		

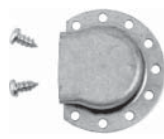
<b>110-122</b>	393760 John Deere AM38289	
<p><b>Muffler Deflector</b> For our 105-080, 105-221, 105-239 mufflers, will also fit our 105-023 and 105-353 mufflers.</p>		

<b>110-152</b>	396548	
<p><b>Muffler Deflector</b> Fits our 105-155, 105-023, 105-353, 105-163, 105-221, 105-239 and 105-061 mufflers.</p>		

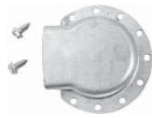
<b>110-130</b>	393757 John Deere PT5035	
<p><b>Muffler Deflector</b> Fits our 105-155 &amp; 105-163 mufflers. Measures: 2-7/8" OD X 5/8" HT</p>		

<b>110-148</b>	393761 John Deere PT9009	
<p><b>Muffler Deflector</b> Fits our 105-254, 105-256 &amp; 105-288 mufflers. Measures: 3-5/16" OD X 5/8" HT</p>		

Part#	O.E.M	Application
-------	-------	-------------

<b>105-296</b>	393840-R91	
<p><b>Muffler</b> For 7, 10 and 12 Hp engines. Fits Kohler models K241, K301 &amp; K321. For garden tractors. Painted black finish. Overall Length: 16-1/2", Inlet ID: 1-3/8", Canister length: 11-1/2", Canister OD: 3-3/4". This is our most popular muffler for custom exhaust modifications.</p>		

GRAVELY

<b>105-262</b>	18543	
<p><b>Muffler</b> For garden tractors. Measures: 8-1/4" L X 3-3/4" OD Inlet ID: 1-5/16", Outlet ID: 1-1/4"</p>		

For HOMELITE mufflers - see "CHAIN SAW ACCESSORIES - O.E.M."







HONDA

<b>105-537</b>	18310-ZMO-000	
<p><b>Muffler</b> Harmony II muffler. Fits models: HRB216, HRR216, HRS216, HRT216, HRZ216. Found on Honda engine models: GCV135 and GCV160. Note: Heat shield NOT included.</p>		

<b>105-577</b>	18310-ZF1-000 Code 3683703	
<p><b>Muffler with Shield</b> Fits 5.5 Hp engines. Model GX160 series engines. Heat shield included - bolted on. Heat Shield Measures: 5-1/2" L X 4-3/16" W, Overall HT: 5-3/4". (Made in Taiwan)</p>		

<b>485-125</b>	18381-ZH8-800 18381-ZH6-800 Code 3683745	
<p><b>Exhaust Gasket</b> Fits 105-577, 105-709 &amp; 105-579 mufflers. For models GX120, GX160 and GX200.</p>		





## HONDA continued

Part#	O.E.M	Application
<b>105-579</b>	18310-ZF1-000 Code 3683703	
<p><b>Muffler with Shield</b> Fits 5.5 Hp engines. Model GX160 series engines. Heat shield included - bolted on. Heat Shield measures: 5-3/8" L X 4-3/4" W, Overall HT: 5-3/4" (Made in China) Comes with spark arrester.</p>		
<b>105-709</b>	18310-ZL0-000 Honda 18320-ZF1-H51 (Shield) Code 4743100 / 4640850	
<p><b>Muffler with Shield</b> Fits 6.5 Hp engines. Model GX200 series engines. Heat shield included - bolted on. Heat Shield measures: 5-3/8" L X 4-3/4" W, Overall HT: 5-3/4" HT Note: Muffler has hole drilled in bottom for bracket support.</p>		
<b>110-041</b>	18320-ZF1-H01 Code 4644811	
<p><b>Muffler Heat Shield</b> Fits our 105-579 &amp; 105-709 mufflers. For GX160 and GX200 series.</p>		
<b>105-571</b>	18310-ZE2-013 Code 2538478	
<p><b>Muffler</b> Fits 8 and 9 Hp engines. Fits model GX240 and GX270 series engines with 2 piece muffler shield (4 hole) Heat shield <b>not</b> included. (4 hole style muffler shield mounting). NOTE: Will accept our 110-043 muffler shield - see next column &gt;</p>		
<b>105-572</b>	18310-ZE2-W00	
<p><b>Muffler</b> Fits 8 and 9 Hp engines. For models GX240 and GX270 series engines with 1 piece muffler shield. Heat shield <b>not</b> included. (2 hole style muffler shield mounting).</p>		
<b>110-043</b>	18320-ZE2-W61 Code 4684098	
<p><b>Muffler Heat Shield</b> Fits our 105-572 and 105-571 mufflers. For GX240 and GX270 series.</p>		

## HONDA continued

Part#	O.E.M	Application
<b>105-701</b>	18310-ZE2-W00 18320-ZE2-W01 (Shield) Code 3678745 Code 4613642	
<p><b>Muffler with Shield</b> Fits 8 and 9 Hp engines. For GX240 and GX270 series engines. Heat shield included. Comes with spark arrester. Measures: 6-1/4" W X 6-1/2" L X 6-1/8" HT. (Uses our 110-402 exhaust pipe and our 486-503, 486-507 and 485-126 exhaust gaskets). Note: Two pictures shown for reference</p>		
<b>105-578</b>	18310-ZE3-003	
<p><b>Muffler</b> Fits 11 and 13 Hp engines. For GX340 and GX390 series engines. Heat shield not included. (Made in Taiwan)</p>		
<b>110-044</b>	18320-ZE3-W01 Code 4640843	
<p><b>Muffler Heat Shield</b> Fits our 105-578 and 105-536 mufflers. For GX340 and GX390 series engines.</p>		
<b>486-507</b>	18333-ZK6-Y00 Code 5164199	
<p><b>Exhaust Pipe</b> Engine to exhaust pipe gasket. Fits our 105-571, 105-572, 105-701, 105-578 and 105-536 mufflers. (Two metal embossed plates fastened together with rivets)</p>		
<b>105-536</b>	18310-ZE2-W61 18320-ZE2-W61 (Shield) Code 6145353 Code 4684098	
<p><b>Muffler with Shield</b> Fits 11 and 13 Hp engines. For GX340 and GX390 series engines. Heat shield included - bolted on. Comes complete with spark arrester. Measures: 7-1/4" W X 6-7/8" L X 5-1/2" HT. (Uses our 110-402 exhaust pipe and our 486-503, 486-507 and 485-126 exhaust gaskets). (Made in China)</p>		

HONDA continued

Part#	O.E.M	Application
<b>110-402</b>	18330-ZE2-W00 18330-ZH9-N00 Code 3678794	
<p><b>Exhaust Pipe</b> Fits our 105-571, 105-572, 105-701, 105-578 and 105-536 mufflers. (Uses our 486-503, 486-507 &amp; 485-126 exhaust gaskets)</p>		
<b>486-503</b>	18381-ZE2-800 18381-ZE2-W10 Code 3678810	
<p><b>Exhaust Gasket</b> Muffler to exhaust pipe gasket. Use with our 105-571, 105-572, 105-578, 105-536 and 105-701 mufflers.</p>		
<b>485-126</b>	18333-ZK6-Y00	
<p><b>Exhaust Pipe</b> Engine to exhaust pipe gasket. Fits our 105-571, 105-572, 105-701, 105-578 and 105-536 mufflers. (Standard metal gasket with asbestos cover on both sides.)</p>		
<b>110-160</b> NEW	18331-883-810 0636563	
<p><b>Muffler Deflector</b> For Honda Mufflers. Fits models: G150, G200, GX120, GX140, GX160 and GX200.</p>		
<b>110-164</b> NEW	18331-ZE3-810 2026227 2108082	
<p><b>Muffler Deflector</b> for Honda engines. Fits models: GX240, GX270, GXV270, GX340, GXV340, GX390 and GXV390.</p>		

For more HONDA muffler / exhaust gaskets see our "GASKETS" section 28

For HUSQVARNA mufflers - see our "AYP" heading and our "CHAIN SAW ACCESSORIES - O.E.M." section

KOHLER

<b>105-247</b>	220145	
<p><b>Muffler</b> For 4 Hp engines. Fits model K91.</p>		

KOHLER continued

Part#	O.E.M	Application
<b>105-248</b>	41 068 01 41 068 08	
<p><b>Muffler</b> For 7 and 8 Hp engines. Fits models K161 and K181.</p>		
<b>105-130</b>	220521 220521-S Tecumseh 29633	
<p><b>Muffler</b> For 4 Hp engines. Fits model K91. 3/4" pipe thread</p>		
<b>105-124</b>	12-068-36-S 12-068-46-S 12-068-47-S 12-068-58-S	
<p><b>Muffler</b> Fits engine models: CH11 thru 15 Measures: 11" overall, Muffler OD: 5" Exhaust Pipe OD: 1-1/4" (2) 3/8" diameter mounting holes on 2-3/8" centres.</p>		
<b>485-799</b>	12 041 03S	
<p><b>Exhaust Gasket</b> Fits our 105-124 muffler. For engine models: CH11 thru 15. Mounting studs on 1-3/4" centre to centre.</p>		
<b>105-122</b>	275679 275679-S Ariens 20033200 B&S 393232 / 392989 B&S 299477 / 299477S Gravely 008227 Gravely 21457900 Gravely 21375300 John Deere AET10410 Tecumseh 32043B	
<p><b>Muffler</b> For 10 thru 23 Hp engines. Fits models M10, M12, M14, M18, M20, K241 thru K321 and K532 thru K582. 1" pipe thread X 1-1/4" ID X 4-1/4" OD X 3-1/4" HT</p>		
<b>105-171</b>	45 068 01 45 068 01-S John Deere ET14015 Wisconsin WD66S1 Wisconsin WD665S1	
<p><b>Muffler</b> For 16 Hp engines. Fits models M16 and K341. 1-1/4" pipe thread X 1-1/2" ID X 4-1/4" OD X 3-3/8" HT.</p>		

## KOHLER continued

Part#	O.E.M	Application
<b>105-296</b>	235945 / 237550 237550S A220521	
<p><b>Muffler</b> For 7, 10 and 12 Hp engines. Fits Kohler models K241, K301 &amp; K321. For garden tractors. Painted black finish. Overall Length: 16-1/2", Inlet ID: 1-3/8", Canister length: 11-1/2", Canister OD: 3-3/4". This is our most popular muffler for custom exhaust modifications.</p>		

## LAWN BOY

<b>105-201</b>	682873	
<p><b>Muffler</b> For 21" home owner walk behinds. Fits models 4261, 4262, 4505A, 7035, 7072, 7072A, 7073, 7250A, 8073, 8073AE, 8600, 8605A and 8671AE.</p>		

<b>486-118</b>	602717	
<p><b>Exhaust Sleeve</b> Fits C and D series mowers. Measures: 1-7/8" L X 7/8" W Sold individually (While Quantities Last)</p>		

<b>486-084</b>	604624	
<p><b>Exhaust Gasket</b> Fits C and D series mowers. Sold individually (While Quantities Last)</p>		

**NOTE: More Lawn Boy mufflers available on-line @www.bantasaw.com \*While Quantities Last\***

## MURRAY

<b>105-256</b>	23343 23483 023342	
<p><b>Muffler</b> For 11 Hp engines. 1" pipe thread, painted silver. Measures: 8" pipe length X 4-1/2" muffler OD. (Uses our 110-023 lock nut and 110-148 muffler deflector).</p>		

<b>105-346</b>	90330SE 90330PA AYP 124097X / 01273 AYP 101273M Poulan 532-101273 Poulan 532-124097 Noma 54766 Toro 110774	
<p><b>Muffler</b> For 11 Hp engines. Measures: 4-1/2" OD X 3" HT Inlet: 1" Includes bolts, heat shield and gasket.</p>		

## MURRAY

Part#	O.E.M	Application
<b>105-510</b>	90330E 91271SE	
<p><b>Muffler</b> For 11 and 12 Hp Briggs equipped Murray front engine riders; model: 9-38219, also fits front engine rider Noma / Dynamark model 3912. Measures: 5" OD X 3-1/2" HT X 1" Inlet ID X 1-1/8" OD, Mounting bolts on 1-7/8" centre to centre.</p>		

## SNAPPER

<b>105-189</b>	1-8198 B&S 299629	
<p><b>Muffler</b> For Snapper Riders with Briggs and Stratton 8 Hp engines. Measures: 5" L X 3-3/8" W X 2-1/8" HT (Use with our 105-205 muffler pipe)</p>		

<b>110-205</b>	1-8197	
<p><b>Muffler Pipe</b> For use on 8 Hp engines. 3/4" pipe (Use with our 105-189 muffler)</p>		

<b>105-270</b>	1-8213 6-0334	
<p><b>Muffler</b> For Snapper Riders with Briggs and Stratton 11 Hp engines. Measures: 7-1/2" L X 3-3/4" OD, Inlet: 1-3/16" (Use with our 105-213 muffler pipe)</p>		

<b>110-213</b>	1-8214	
<p><b>Muffler Pipe</b> For use on 11 Hp engines. 1" pipe (Use with our 105-270 muffler)</p>		

<b>105-033</b>	5-1996	
<p><b>Muffler</b> For use on 12 and 12-1/2 Hp Briggs and Stratton engines found on Snapper riders.</p>		

For STIHL mufflers - see our section "CHAIN SAW ACCESSORIES - O.E.M."

TECUMSEH

Part#	O.E.M	Application
-------	-------	-------------

**105-049** 27181B / 27181C / 30082A / 30996

**Muffler**  
For 2-1/2 thru 3-1/2 Hp engines.  
Bolt on style. Fits ECV100, LAV35 and TVS75-TVS120.  
Measures: 2-3/16" OD X 1-15/16" L. Includes bolts & gasket



**105-361** 35603

**Muffler**  
For Tecumseh Premier engines.  
Models TVS120 and XL series engines. Includes bolts



**105-213** 35771 / 33697A / 32648A  
John Deere AM108653

**Muffler**  
For 4 thru 7 Hp horizontal engines. Fits model HS40, HS50, LAV40, LAV50, H60, H70, TVS75 thru TVS120 and TVXL105.  
Bolt on style. (Uses our 485-714 mount gasket)



**485-714** 26754A

**Exhaust Gasket**  
Fits models H30, H35 and H40.  
Use with our 105-049, 105-213 and 105-361 mufflers.  
(Sold in multiples of 10)



**105-205** 32401  
John Deere AM33478

**Muffler**  
For 4 thru 7 Hp horizontal engines.  
Found on many Snowblowers.  
Fits models H40 thru H70, V50, V60, V70 and TVM140.  
Bolt on style (Uses our 485-904 mount gasket)



**485-904** 27930A / 35865  
John Deere M45347  
Snapper 1-2422

**Exhaust Gasket**  
Fits models H50, V70 and HM100.  
For 3.5 thru 10 Hp engines.  
(Use with our 105-205 mufflers). (Sold in multiples of 10)



**105-130** 29633

**Muffler**  
For 6, 7 and 8 Hp engines.  
Fits model H60, H70, V60, V70, HM80 and VM80 series.



**105-114** 33280A  
33280

**Muffler**  
For 7 thru 10 Hp engines.  
Fits models VM100, TVM170 thru TVM220 and HM70 thru HM100 and VM100. (Uses our 495-924 exhaust gasket).  
Requires (2) 5/16-18 X 3" bolts - NOT included.



TECUMSEH continued

Part#	O.E.M	Application
-------	-------	-------------

**485-924**

**Exhaust Gasket**  
Fits 7 thru 10 Hp engines.  
Fits 105-114 and 105-365  
(Sold in multiples of 10)



**105-365** 35056  
94058

**Muffler**  
For 8 thru 10 Hp engines.  
Found on newer style Snowblowers, Snow King etc.  
Heavy gauge steel construction with bracket welded in place. Bolt on type.  
(Uses our 485-924 exhaust gasket)  
Requires (2) 5/16-18 X 4" bolts - NOT included.



TORO / WHEEL HORSE

**105-072** 5-4769

**Muffler**  
For self propelled mowers.  
Measures: 2-3/4" L X 2-1/8" OD  
Includes bolts, locking plate & gasket.



**105-197** 2-9319

**Muffler**  
For push mowers.  
Measures: 1-1/2" L X 2-3/4" OD  
Includes bolts, locking plate & gasket.



**105-346** 110774  
AYP 101273  
AYP 101273M / 124097X  
Noma 54765 / 54766  
Poulan & Husqvarna#s  
532-124097 / 532-101273

**Muffler**  
For 11 Hp engines.  
Measures: 4-1/2" OD X 3" HT Inlet: 1"  
Include bolts, heat shield and gasket.



UNIVERSAL

**110-425** 1" ID X 1-3/16" OD

**Flexible Metal Hose**  
Priced and Sold Per Foot.  
Size: 1" ID X 1-3/16" OD.  
Ideal for re-routing exhaust and/or reducing exhaust noise. Strip wound inter-locking hose made from hot-dipped galvanized carbon steel.  
Rated for service conditions to 750 degrees fahrenheit.

*Priced and sold Per Foot*

