

## Features of the BANTA "OIL FILTERS"

- > **Metal Shell**
- > **Relief Valve Assembly** (relief valve opens when necessary to provide engine with oil under all conditions).
- > **Anti-Drain Back Valve** (Anti-drain back valve prevents oil from draining out of the filter during engine shutdown).
- > **Metal End Cap - both top & bottom** (Metal end caps and thermo setting adhesive provide positive seals).
- > **Resin Impregnated Paper Filter Medium** (Cured resin impregnated paper removes harmful foreign particles).
- > **Lid Assembly** (Lid assembly is roll seamed to the shell which provides a leak-tight assembly).



- < ----- Metal Shell
- Relief Valve Assembly
- < ----- Resin Impregnated Paper Filter Medium
- Anti-Drain Back Valve

## OIL FILTERS - BUY THE SHOP PACK and SAVE BIG

Part#	OEM#	Application
<b>120-904</b> <b>SAVE BIG</b>	Cub Cadet# CC-12-050-08 Gravely# 21397200 John Deere# AM125424 John Deere# KH1205008 Kohler# 12 050 01 Kohler# 12 050 01-S Lesco# 032009 Toro# 98020 Woods# 70820	<b>OIL FILTER SHOP PACK</b> - (12) of our 120-523 oil filters. > 8 to 11 PSI pressure relief > anti drain valve > 3/4"-16 thread > 3" OD X 2-3/4" HT > 27 Micron
<b>120-901</b> <b>SAVE BIG</b>	B&S# 4154 B&S# 492056 B&S# 492932 B&S# 492932S B&S# 696854 Tecumseh# 36563 Tecumseh# 36961	<b>OIL FILTER SHOP PACK</b> - (12) of our 120-485 oil filters. > 7 to 9 PSI pressure relief > anti drain valve > 3/4"-16 thread > 3" OD X 2-5/16" HT > Seal OD: 2-13/16" > 28 Micron
<b>120-902</b> <b>SAVE BIG</b>	B&S# 499532 B&S# 692513 Club Car# 41016467 Cub Cadet# 490-201-001 Cushman# 833438 Generac# 70185 Gravely# 043594 / 21535800 Gravely# 20777000 / 21527900 / 21480600 John Deere# AM101054 / AM101207 / AM107423 Kawasaki# 49065-2078 / 49065-2071 Kawasaki# 49065-2062 / 49065-2057 Kees# 363312, Onan# 122-0737 / 122-0737-03 Robin# 248-65801-00 / 261-65902-A0, Snapper# 7-7355 / 7077288, Tecumseh# 36262, Toro# NN10684, Woods# 72859	<b>OIL FILTER SHOP PACK</b> - (12) of our 120-634 oil filters. > 9 to 12 PSI pressure relief > anti drain valve > 3/4"-16 thread > 2-11/16" OD X 2-15/16" HT > 28 Micron
	<p style="text-align: right;"><b>OUR BEST SELLER</b></p>	
<b>120-903</b> <b>SAVE BIG</b>	B&S# 4153 B&S# 491056 Case# C26191 Gravely# 042366 John Deere# AM101207 Kohler# 52 050 02 Kohler# 52 050 02-S Onan# 122-0645 Toro# NN10147 Woods# 70939	<b>OIL FILTER SHOP PACK</b> - (12) of our 120-345 oil filters. > 8 to 11 PSI pressure relief > anti drain valve > 3/4"-16 thread > 3" OD X 3-1/4" HT > 27 Micron

## ARIENS

Part#	OEM#	Application
<b>120-519</b>	Ariens# 31928 Ariens# 03192800 Bolens# 1719859 Bolens# 1726450	
<b>Transmission Filter</b> For most Tractors with hydrostatic transmissions; 8 to 11 PSI pressure relief. Size: 3/4"-16 thread X 3-13/16" OD X 3-23/32" HT; Mounting seal OD: 2-13/16"; Anti drain valve, 28 Micron.		

## BOBCAT

<b>120-501</b>	Bobcat# 48045B	(While Quantities Last)
<b>Transmission Filter</b> 8 to 11 PSI pressure relief. For XM Hydro series and 700 series. 3/4"-16 thread X 3-13/16" OD X 2-3/4" HT; Anti drain valve; 16 Micron.		
		

For BOLENS - see ARIENS and TROY BILT

## BRIGGS and STRATTON

<b>120-485</b>	B&S# 4154 B&S# 492932 / 492932S B&S# 492056 / 696854	
<b>Oil Filter</b> For 5 Hp Vanguard engines. Fits models 104700, 261700, 290700, 294700, 303700 and 350700; 3/4"-16 thread X 3" OD X 2-5/16" HT, 2-13/16" Seal OD, Anti drain valve, 28 micron; 7 to 9 PSI pressure relief <b>(Vanguard models small version filter)</b> NOTE: SAVE "SHOP PACK of 12" available - Banta Saw order# 120-901		

<b>120-345</b>	B&S# 4153 B&S# 491056 / 491056S	
<b>Oil Filter</b> For most Vanguard series and twin cylinder engines. Fits models: 260700, 261700 and 290700. 8 to 11 PSI pressure relief, 3/4"-16 thread X 3" OD X 3-1/4" HT, Anti drain valve, 27 micron <b>(Vanguard models large version filter)</b> NOTE: SAVE "SHOP PACK of 12" available - Banta Saw order# 120-903		

<b>120-634</b>	B&S# 70185 B&S# 499532 Generac# 70185	
<b>Oil Filter</b> Found on Briggs Generac models. 3/4"-16 thread X 2-11/16" OD X 2-15/16" HT, Anti drain valve, 28 micron. Mounting seal: 2-1/2" OD; 9 to 12 PSI pressure relief, NOTE: SAVE "SHOP PACK of 12" available - Banta Saw order# 120-902		

## BRIGGS and STRATTON

Part#	OEM#	Application
<b>120-285</b>	B&S# 692513	
<b>Oil Filter</b> For 6.5 Hp Intek Pro model engines. Models 122600 and 123600.		

<b>125-211</b>	B&S# 66768 / B&S# 281685 John Deere# M47797 Tecumseh# 27625	
<b>Oil Fill Plug</b> For most Briggs and Stratton, Clinton and Tecumseh engines with angled oil fill neck. Made of the finest nylon available.		

<b>125-225</b>	B&S# 691913 B&S# 280485 B&S# 281081	
<b>Oil Plug with built in Dipstick.</b> Fits 4 Hp vertical shaft engines. Models: 114900 thru 114995		

<b>125-218</b>	B&S# 280663	
<b>Oil Plug with dipstick</b> For Briggs and Stratton Quantum engines.		



<b>125-413</b>	B&S# 68838 B&S# 281370 B&S# 805259	
<b>Oil Grommet</b> For 7 and 11 Hp horizontal, 12 and 13 Hp vertical and Vanguard V-Twin horizontal engines with extended plastic dip sticks.		

<b>125-294</b>	B&S# 92738 / 690289 Kohler# X-305-4 / X-305-4-S	
<b>Magnetic Oil Plug</b> Size: 3/8"-18 pipe thread. (Sold in multiples of 5)		

<b>125-302</b>	B&S# 94174 B&S# 94687 / 691663 Kohler# X-75-10 X-75-10-S / 25 139 57-S	
<b>Magnetic Oil Plug</b> Fits 2 - 5 HP engines. (Sold in multiples of 5) Size: 1/4"-18 pipe thread.		

<b>125-203</b>	B&S# 296768 B&S# 692939	
<b>Oil Minder Gauge</b> - For Briggs, Clinton and Tecumseh engines. Permanently replaces oil filler plug with the "oil minder". Press rubber bulb and release. If oil can be seen, oil level is OK.		

CASE and CUB CADET

Part#	OEM#	Application
<b>120-345</b>	Case# C26191	
<b>Oil Filter</b> 3/4" - 16 thread X 3" OD X 3-1/4" HT. 8 to 11 PSI pressure relief Anti drain valve, 27 micron (Vanguard models large version filter)		
<b>120-360</b>		
<b>Oil Filter</b> Fits models 107, 117, 220 and 444. 11 to 14 PSI pressure relief M20 X 1.5 thread X 3" OD X 3-1/8" HT Anti drain valve, 27 Micron		
<b>120-519</b>	Cub Cadet# 723-3014 Cub Cadet# 923-3014 Cub Cadet# 759-3605 Cushman# 111836 IH-395789-R-2	
<b>Transmission Filter</b> For hydrostatic transmissions. 8 to 11 PSI pressure relief, anti drain valve 3/4" - 16 thread X 3-13/16" OD X 3-3/4" HT Mounting seal OD: 2-13/16", 28 Micron (For other oil filter for Cub Cadet see our part# 120-523 - Cub Cadet# CC-12-050-08 and part# 120-634 - Cub Cadet# 490-201-001)		

DIXON and ENCORE

<b>120-361</b>	Dixon# 5565 Dixon# 7252 Encore# 423063	
<b>Transmission Filter</b> Fits models 501, 502, 5501, 5421 and 5601. 3/4"-16 thread X 3" OD X 3-7/8" HT, 18 PSI pressure relief; Mounting seal OD: 2-3/4", 10 Micron		

EXMARK and FERRIS

<b>120-362</b>	Exmark# 109-3321 Hustler# 768341 Hustler# 600976 Scag# HG52114	
<b>Oil Filter</b> Found on Exmark, Hustler and Scag models. Replaces Hydro Gear Hg52114. Fits (Transmission Model ZT2800). Replaces Scag HG52114, fits Freedom Z. Size: 2-11/16" OD X 3" HT, Mounting seal OD: 2-1/2".		

EXMARK and FERRIS

Part#	OEM#	Application
<b>120-361</b>	Exmark# 513211	
<b>Transmission Filter</b> Fits models 501, 502, 5501, 5421 and 5601. 3/4"-16 thread X 3" OD X 3-7/8" HT, 18 PSI pressure relief; Mounting seal OD: 2-3/4", 10 Micron		
<b>120-710</b>	Exmark# 103-2146 Ferris# 1521357	
<b>NEW</b> <b>Transmission Filter</b> Fits Exmark models: Front Runner and Lazer Z. Most Ferris Zero Turn mowers, also found on Toro mowers. 1"-12 thread X 3-3/4" OD X 5-1/4" HT, Anti drain valve, 25 micron		

GRAVELY

<b>120-600</b>	Gravely# 12722 Gravely# 12722-PI	(While Quantities Last) 
<b>Oil Filter</b> For 7.6 "L" series tractors. 8 to 11 PSI pressure relief 3/4" - 16 thread X 3-3/4" OD X 4-1/4" HT Anti drain valve, 20 - 25 Micron		
<b>120-634</b>	Gravely# 20777000 Gravely# 21480600 Gravely# 21527900 Gravely# 21535800 Gravely# 043594 Cub Cadet# 490-201-001	
<b>Oil Filter</b> For models with Kawasaki engines. 3/4"-16 thread X 2-11/16" OD X 2-15/16" HT; Mounting seal OD: 2-1/2" 9 to 12 PSI pressure relief, Anti drain valve, 28 Micron		
<b>120-345</b>	Gravely# 042366	
<b>Oil Filter</b> For most Vanguard series and twin cylinder engines. Fits models: 260700, 261700 and 290700. 8 to 11 PSI pressure relief, 3/4"-16 thread, 3" OD X 3-1/4" HT, Anti drain valve, 27 Micron Mounting seal OD: 2-1/2"		
<b>120-523</b>	Gravely# 21397200	
<b>Oil Filter</b> For models with Kohler engines. 8 to 11 PSI pressure relief 3/4"-16 thread X 3" OD X 2-3/4" HT Anti drain valve, 27 micron		



## GRAVELY continued

Part#	OEM#	Application
<b>120-519</b>	Gravelly# 39306	
<b>Transmission Filter</b> For Pro Master 400 series. 8 to 11 PSI pressure relief, anti drain valve 3/4" - 16 thread X 3-13/16" OD X 3-3/4" HT; Mounting seal OD: 2-13/16", 28 Micron		
		





## HONDA & HUSQVARNA

<b>120-360</b>	Honda# 15410-MJ0-004 Honda# 15400-679-033 Honda# 15400-PR3-004 Honda# 15410-MB0-000 Honda# 15410-MJ0-003 Honda# 15400-POH-305 Honda# 15410-MJ0-405	
<b>Oil Filter</b> For water cooled engines. Fits model IEM5000. 11 to 14 PSI pressure relief, M20 X 1.5 thread 3" OD X 3-1/8" HT, Anti drain valve, 27 micron		
<b>120-383</b>	Honda# 15410-MCJ-000 Honda# 15410-MCJ-003	
<b>Oil Filter</b> Fits model GXV530, 16 Hp V-Twin. M20 X 1.5mm 2.685" OD X 2.782" HT		
<b>120-361</b>	Honda# 25641-ZE4-003 Honda# 25641-VE4-003 Husqvarna# 539 10 26-06 Kees# 101164 Yazoo# 101164	
<b>Transmission Filter</b> Fits models HRC7013, HRC7018 and HRC7020. 3/4" - 16 thread X 3" OD X 3-7/8" HT Mounting seal OD: 2-3/4", 18 PSI pressure relief; 10 micron		
<b>125-264</b>	Honda# 15600-ZG4-003 Code# 4497921	
<b>Oil Fill Cap</b> Fits models GX110, GX120, GX140, GX160, GX200, GX240, GX270, GX340, GX390.		
<b>125-240</b>	Honda# 15600-ZG4-003 Honda# 15600-ZE1-003 Code# 4500146	
<b>Oil Dipstick and Gasket</b> Fits models GX110, GX120, GX140, GX160,		

## HONDA continued





Part#	OEM#	Application
<b>125-241</b>	Honda# 15650-ZM0-801	
<b>Oil Dipstick and Gasket</b> Fits models: GCV135 and GCV160		
		
<b>125-239</b>	Fits Honda	
<b>NEW</b>		
<b>Oil Drain Valve - Fits Honda</b> Metric M14 X 1.5 thread.		
		

## JOHN DEERE

<b>120-638</b>	John Deere# M806418	
<b>NEW</b>		
<b>Oil Filter</b> Fits John Deere models: 1420, 1435, 1445, F735, F912, F915, F925, F935, 425, 445, 455, HPX Gator, 2500 and 2500A Greensmowers. 2-5/8" OD X 2-1/2" HT; 11 to 14 PSI pressure relief; M20 X 1.5 thread; Anti drain valve, 20 Micron		
		
<b>120-345</b>	John Deere# AM101207	
<b>Oil Filter</b> For models with Kohler engines. 3/4" - 16 thread X 3" OD X 3-1/4" HT 8 to 11 PSI pressure relief Anti drain valve, 27 micron <b>NOTE:</b> SAVE "SHOP PACK of 12" available - Banta Saw order# 120-903		
		
<b>120-523</b>	John Deere# AM125424 John Deere# KH1205008	
<b>Oil Filter</b> For John Deere lawn tractors SST15, L100 and LX173 with Kohler engines. Fits Kohler engine models: CH18 thru Ch25, CV18 thru CV25 and K582. 3/4" - 16 thread X 3" OD X 2-3/4" HT 8 to 11 PSI pressure relief Anti drain valve, 27 micron		
		
<b>120-634</b>	John Deere# AM101054 John Deere# AM101207 John Deere# AM107423	
<b>Oil Filter</b> For models with Kawasaki engines. Fits John Deere lawn tractors 112L, LX172 and LX176 with Kawasaki engines; front mount F510. 3/4" - 16 X 2-11/16" OD X 2-15/16" HT Mounting seal OD: 2-1/2" 9 to 12 PSI pressure relief; Anti drain valve, 28 micron <b>NOTE:</b> SAVE "SHOP PACK of 12" available - Banta Saw order# 120-902		
		





JOHN DEERE continued

KAWASAKI (For ATV filters - see section 30)

Part#	OEM#	Application
<b>120-626</b>	John Deere# AM39687 John Deere# AM34770	
<b>Oil Filter</b> For models with Kohler engines. 3/4" - 16 thread X 3" OD X 5-1/8" HT; Mounting seal OD: 2-7/8" 8 to 11 PSI pressure relief, Anti drain valve; 28 micron		
<b>120-360</b>	John Deere# AM101378 John Deere# M806418	
<b>Oil Filter</b> Fits models 300, 400, F912, 915, 925, 932 and 935 series. M20 X 1.5 thread 3" OD X 3-1/8" HT 11 to 14 PSI pressure relief, Anti drain valve, 27 micron		
<b>120-519</b>	John Deere# AM39653 John Deere# AM35176 John Deere# AM31205 John Deere# AM38441	
<b>Transmission Filter</b> Front mount mowers F911, F912, F915, F925 F932 and F935; Z-trak mowers F620, F680, F687, F737 and F757; Lawn tractors: 140, 230, 300, 312, 314, 316, 317, 318, 322, 330, 332, 400, 420, 430 and 900 series. 8 to 11 PSI pressure relief, anti drain valve 3/4" - 16 thread X 3-13/16" OD X 3-3/4" HT Mounting seal OD: 2-13/16, 25/30 Micron		
<b>120-512</b>	John Deere# AM131053	
<b>Transmission Filter</b> Fits Groundsmaster 300 series. For new Pro Line commercial mowers. 1" - 12 thread 3-3/4" OD X 3-5/8" HT Rubber Seal OD: 2-7/8", 10 micron		
<b>125-235</b>	John Deere# AM115362	
<b>NEW</b> <b>Oil Drain Valve</b> Fits John Deere models equipped with Kawasaki engines. <b>Metric M16 X 1.5 thread.</b>		

Part#	OEM#	Application
<b>120-634</b>	Kawasaki# 49065-2078 Kawasaki# 49065-2074 Kawasaki# 49065-2071 Kawasaki# 49065-2070 Kawasaki# 49065-2062 Kawasaki# 49065-2057 Kees# 363312	
<b>Oil Filter</b> Fits most models. 3/4" - 16 thread X 2-11/16" OD X 2-15/16" HT; Mounting seal OD: 2-1/2" 9 to 12 PSI pressure relief; Anti drain valve, 28 micron <b>NOTE: SAVE "SHOP PACK of 12" available - Banta Saw order# 120-902</b>		

KOHLER

<b>120-345</b>	Kohler# 52 050 02 Kohler# 52 050 02-S	
<b>Oil Filter</b> Fits models KT17 thru 19, M18 thru 20, MV16 thru 20 series, CH11 thru 14 and CV11 thru 15 Pro series. 3/4" - 16 thread X 3" OD X 3-1/4" HT Mounting seal OD: 2-13/16" 8 to 11 PSI pressure relief, Anti drain valve, 27 micron		
<b>120-523</b>	Kohler# 12 050 01 Kohler# 12 050 01-S Woods# 70820	
<b>Oil Filter</b> Fits models CH18 thru 25, CV18 thru 25 and K582. 3/4" - 16 thread X 3" OD X 2-3/4" HT Mounting seal OD: 2-13/16" 8 to 11 PSI pressure relief, Anti drain valve, 27 micron		
<b>120-626</b>	Kohler# 277233 Kohler# 277233-S	
<b>Oil Filter</b> Fits models K482, K532 and K582. 3/4" - 16 thread 3" OD X 5-1/8" HT Mounting seal OD: 2-7/8" 8 to 11 PSI pressure relief, Anti drain valve, 28 micron		
<b>125-237</b>	Kohler# 25 462 08 Kohler# 25 755 14 Kohler# 25 755 14S Tecumseh# 37651	
<b>Oil Drain Valve</b> Adapts to most 8 Hp and larger engines. Permanent mount on engines. - 1/2" drain hose connection, - 3/8" - 18 NPTF thread		





KAWASAKI

<b>125-235</b>	Kawasaki# 99969-1395	
<b>NEW</b> <b>Oil Drain Valve</b> Fits Kawasaki engines. Used on John Deere and Scag equipment etc. <b>Metric M16 X 1.5 thread.</b>		

## KUBOTA

Part#	OEM#	Application
<b>120-359</b> <b>NEW</b>	Kubota# 15241-32090 Grasshopper100800	
<b>Oil Filter</b> Fits many B, BX, G, F, U and ZD series Kubota's. Fits diesel engines. 20mm X 1.5mm X 3.243" OD X 2.944" HT.		
<b>120-360</b>	Kubota# 70000-15241 Kubota# 70000-74034 Kubota# 30401-37580 Troy Bilt# 1874139	
<b>Oil Filter</b> Fits models T1600H, D600, D650, D750, D850 and D950. 11 to 14 PSI pressure relief M20 X 1.5 thread X 3" OD X 3-1/8" HT Rubber seal OD: 2-1/2", anti drain valve, 27 micron		
<b>120-383</b>	Kubota# 15853-32430 Kubota# 15853-99179 Honda# 15410-MCJ-000 Toro# 93-4295	
<b>Oil Filter</b> Smaller version of our 120-360. M20 X 1.5 thread X 2-5/8" OD X 2-3/4" HT, Rubber seal OD: 2-1/2", anti drain valve.		
<b>120-286</b>	Kubota# 70000-32091	
<b>Oil Filter</b> Fits models L175, L275, L235, L260, F345, L355, L2250, L2500, L2850, 4000 series, 5030, D1100 and F2302. 3-7/8" OD X 4-1/8" HT, Rubber Seal OD: 2-13/16" 8 to 11 PSI pressure relief, anti drain valve.		
<b>120-597</b>	Kubota# 66021-36060 Perkins# 1405161-90 Toro# 85-4930	
<b>Transmission Filter</b> Fits all "B" series Kubota as well as Perkins and Toro. (Replaces Perkins# 1405161-90) 3/4"-16 Thread, 3" OD X 4-1/16" HT; Mounting seal OD: 2-3/4"; 25 Micron		

## ONAN

Part#	OEM#	Application
<b>120-634</b>	Onan# 122-0737 Onan# 122-0737-03	
<b>Oil Filter</b> Fits model E125V with Kawasaki engine. 3/4" - 16 2-11/16" OD X 2-15/16" HT Mounting seal OD: 2-1/2" 9 to 12 PSI pressure relief; Anti drain valve, 28 micron		
<b>120-345</b>	Onan# 122-0645	
<b>Oil Filter</b> Fits models P216, 218, 220, BFA, BGA, BGAL, BGD, BGD L, BGE, BGEL, BGM, B43G & B48GM. 3/4" - 16 thread X 3" OD X 3-1/4" HT 8 to 11 PSI pressure relief; Anti drain valve, 27 micron		
<b>120-517</b>	Onan# 122-0800 Onan# 122-0323 Onan# 122-0445	
<b>Oil Filter</b> Fits 16 and 20 Hp twin cylinder models from 1989 thru 1994. 3/4" - 16 3" OD X 4-5/8" HT 8 to 11 PSI pressure relief, Anti drain valve, 25 - 30 micron		
<b>120-626</b>	Onan# 122-0469	
<b>Oil Filter</b> Fits models NA, NHB, NHC, NHP, N52M, P224 and T260. 3/4" - 16 thread 3" OD X 5-1/8" HT Mounting seal OD: 2-7/8" 8 to 11 PSI pressure relief, Anti drain valve, 28 micron		
<b>120-519</b>	Onan# 122-0185	
<b>Transmission Filter</b> Fits models JA, JB, JC and JF. 3/4" - 16 thread 3-13/16" OD X 3-3/4" HT Mounting seal OD: 2-13/16" 8 to 11 PSI pressure relief, anti drain valve, 28 micron		





## MTD

<b>120-519</b>	MTD# 727-0162	
<b>Transmission Filter</b> For hydrostatic transmissions. 3/4" - 16 thread 3-13/16" OD X 3-3/4" HT Mounting seal OD: 2-13/16" 8 to 11 PSI pressure relief, anti drain valve, 28 micron		

## SCAG

<b>120-512</b>	Scag# 48462-01	
<b>Transmission Filter</b> Fits Hydro units. 1" - 12 thread 3-3/4" OD X 3-5/8" HT Rubber Seal OD: 2-7/8", 10 micron		

SCAG continued

Part#	OEM#	Application
<b>120-362</b> <b>NEW</b>	Scag# HG52114	
<p><b>Oil Filter</b> Replaces Scag Hydro Gear Hg52114. Fits (Transmission Model Zt2800). Replaces Scag HG52114, fits Freedom Z. Also found on Exmark, Hustler and Scag models. Size: 2-11/16" OD X 3" HT, Mounting seal OD: 2-1/2".</p>		
<b>125-235</b> <b>NEW</b>	Scag# 482351	
<p><b>Oil Drain Valve</b> Fits many Scag models equipped with Kawasaki engines. <b>Metric M16 X 1.5 thread.</b></p>		
<b>125-238</b> <b>NEW</b>	Scag# 482352	
<p><b>Oil Drain Valve</b> Fits Scag and also some Kawasaki 19 thru 25 Hp vertical engines. <b>3/8" - 18 NPTF threads</b></p>		
<b>125-236</b> <b>NEW</b>	Scag# 482349	
<p><b>Oil Drain Valve</b> Fits Scag and also some Kawasaki 19 thru 25 Hp vertical engines. <b>Metric M20 X 2.5mm threads</b></p>		

SIMPLICITY

<b>120-519</b>	Simplicity# 171439 Simplicity# 1650954	
<p><b>Transmission Filter</b> Fits Sunstrand hydro models. 3/4" - 16 thread 3-13/16" OD X 3-3/4" HT Mounting seal OD: 2-13/16 8 to 11 PSI pressure relief, anti drain valve, 28 Micron</p>		

SNAPPER

<b>120-634</b>	Snapper# 7-7355	
<p><b>Oil Filter</b> For Snappere models equipped with Kawasaki engines. 3/4" - 16 thread 2-3/4" OD X 2-15/16" HT Mounting seal OD: 2-11/16" 9 to 12 PSI pressure relief, Anti drain valve, 28 micron</p>		



SNAPPER continued

Part#	OEM#	Application
<b>120-512</b>	Snapper# 2-7164 Snapper# 7027164	
<p><b>Transmission Filter</b> Fits Hydro units. 1" - 12 thread 3-3/4" OD X 3-5/8" HT Rubber Seal OD: 2-7/8", 10 micron</p>		

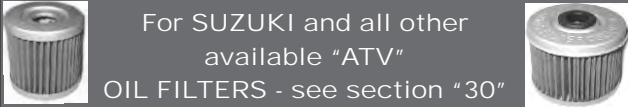

For SUZUKI and all other available "ATV"  
OIL FILTERS - see section "30"









TECUMSEH

<b>120-485</b>	Tecumseh# 36563 Tecumseh# 36961	
<p><b>Oil Filter</b> Fits models OHV130, OHV135, OHV150, OHV155, OHV165, OHV175, OHV180, TVT691, OV and VTX. 3/4" - 16 thread X 3" OD X 2-5/16" HT, Rubber seal OD: 2-13/16", 7 to 9 PSI pressure relief, Anti drain valve, 28 micron <b>NOTE: SAVE "SHOP PACK of 12" available - Banta Saw order# 120-901</b></p>		
<b>120-634</b>	Tecumseh# 36262	
<p><b>Oil Filter</b> For models OHV15 specs 204003, 204005, 204010, 204013 and OHV16 specs 204205A. 3/4" - 16 thread 2-11/16" OD X 2-15/16" HT, Mounting seal OD: 2-1/2" 9 to 12 PSI pressure relief, Anti drain valve, 28 micron. <b>NOTE: SAVE "SHOP PACK of 12" available - Banta Saw order# 120-902</b></p>		

TORO / WHEEL HORSE

<b>120-634</b>	Toro# NN10684 Woods# 72859	
<p><b>Oil Filter</b> Fits models with Kawasaki engines. 3/4" - 16 thread 2-11/16" OD X 2-15/16" HT, Mounting seal OD: 2-1/2", 9 to 12 PSI pressure relief; Anti drain valve, 28 micron</p>		
<b>120-523</b>	Toro# 98020	
<p><b>Oil Filter</b> For models with Kohler engines. 3/4" - 16 thread 3" OD X 2-3/4" HT Mounting seal OD: 2-13/16" 8 to 11 PSI pressure relief; Anti drain valve, 27 micron</p>		



## TORO / WHEEL HORSE

Part#	OEM#	Application
<b>120-345</b>	Toro# NN10147 Woods# 70939	
<b>Oil Filter</b>		Fits models with Kohler engines. 3/4" - 16 thread 3" OD X 3-1/4" HT Mounting seal OD: 2-13/16" 8 to 11 PSI pressure relief, Anti drain valve, 27 micron
<b>120-517</b>	Toro# NN10143	
<b>Oil Filter</b>		Fits 16 and 20 Hp twin cylinder models from 1989 thru 1994. 3/4" - 16 thread 3" OD X 4-5/8" HT 8 to 11 PSI pressure relief, Anti drain valve, 25 - 30 micron
<b>120-710</b>	Toro# 28-1370 Toro# 54-0110	
<b>NEW</b> <b>Transmission Filter</b>		Fits Toro / Wheel Horse Groundsmaster 117 and 118 models, Greenmaster 3, Turfpro and SandPro models. Thread Size: 1"-12, 3-3/4" OD X 5-1/4" HT, 25 / 28 Micron, Anti-Drain.
<b>120-519</b>	Toro# 108335 Toro# 79-5270	
<b>Transmission Filter</b>		For hydrostatic transmissions. Fits hydro models 300, 400 and 500 series. 3/4" - 16 thread 3-13/16" OD X 3-3/4" HT Mounting seal OD: 2-13/16" 8 to 11 PSI pressure relief, Anti drain valve, 28 micron
<b>120-220</b>	Toro# 23-2300	
<b>Transmission Filter</b>		Large version of our 120-361. Will fit both applications listed - see actual size below. Fits Toro Groundsmaster models 217, 220, 322 and 327 series. 3/4" - 16 thread 3-13/16" OD X 3-7/8" HT; mounting seal OD: 2-13/16" 8 to 11 PSI pressure relief, Anti drain valve, 10 micron
<b>120-361</b>	Toro# 23-9740 Toro# 63-3750 Toro# E63-3750	
<b>Transmission Filter</b>		Small version of our 120-220. For hydrostatic transmissions. 3/4" - 16 thread 3" OD X 3-7/8" HT; mounting seal OD: 2-13/16" 8 to 11 PSI pressure relief, Anti drain valve, 10 micron

## TORO / WHEEL HORSE

Part#	OEM#	Application
<b>120-512</b>	Toro# 67-8110	
<b>Transmission Filter</b>		Fits Groundsmaster 300 series. For new Pro Line commercial mowers. 1" - 12 thread 3-3/4" OD X 3-5/8" HT Mounting seal OD: 2-7/8", 10 micron
<b>120-464</b>	Toro# 63-3752 Toro# E63-3752 Dixie Chopper# 68140 Exmark# 523541	
<b>Transmission Filter</b>		For hydrostatic transmissions. 3/4" - 16 thread 3" OD X 3-7/8" HT 40 micron

## TROY BILT and YANMAR

<b>120-519</b>	Troy Bilt# 1719859 Troy Bilt# 1726450	
<b>Transmission Filter</b>		Fits models 1455, 1476, 1477, 166, 1660, 1666, 1886, 194, 197, 198, 2086, 2087, QT-16, 13060, 13062, 13074 and 13076 hydro garden tractors and 13101 GTX hydro garden tractors. 3/4" - 16 thread X 3-13/16" OD X 3-3/4" HT 8 to 11 PSI pressure relief, anti drain valve Mounting seal OD: 2-13/16", 28 micron
<b>120-360</b>	Troy Bilt# 1874139 Yanmar# 129150-35150	
<b>Oil Filter</b>		Fits model 1704 with 17 Hp Diesel engine. M20 X 1.5 thread 3" OD X 3-1/8" HT Mounting seal: 2-1/2" OD, 11 to 14 PSI pressure relief, Anti drain valve, 27 micron
<b>120-220</b>	Troy Bilt# 1719859 Troy Bilt# 1726450	
<b>Transmission Filter</b>		Fits Troy Bilt models 1455, 1476, 1477, 166, 1660, 1666, 1886, 194, 197, 198, 2086, 2087, QT-16; 13060, 13060, 13062, 13074 and 13076 hydro garden tractors; 13101 GTX hydro garden tractors. 3/4" - 16 thread X 3-3/16" OD X 3-23/32" HT 8 to 11 PSI pressure relief, Anti drain valve, 10 micron