

UNIVERSAL "6000" SERIES

Part#	Bearing#	ID	OD	Height
230-600	6000-2RS	10mm (0.393)	26mm (1.023)	8mm (0.315)
230-603	6003-2RS	17mm (0.669)	35mm (1.378)	10mm (0.393)
230-605	6005-2RS	25mm (0.984)	47mm (1.850)	12mm (0.472)
230-606	6006-2RS	30mm (1.181)	55mm (2.165)	13mm (0.511)
230-607	6007-2RS	35mm (1.378)	62mm (2.440)	14mm (0.551)
230-608	6008-2RS	40mm (1.574)	68mm (2.677)	15mm (0.590)



UNIVERSAL "6200" SERIES

Part#	Bearing#	ID	OD	Height
230-620	6200-2RS	10mm (0.393)	30mm (1.181)	9mm (0.354)
230-621	6201-2RS	12mm (0.472)	32mm (1.259)	10mm (0.393)
230-622	6202-2RS	15mm (0.590)	35mm (1.378)	11mm (0.433)
230-626	6206-2RS	30mm (1.181)	62mm (2.440)	16mm (0.629)
230-627	6207-2RS	35mm (1.378)	72mm (2.834)	17mm (0.669)
230-628	6208-2RS	40mm (1.574)	80mm (3.149)	18mm (0.708)



UNIVERSAL "6300" SERIES

Part#	Bearing#	ID	OD	Height
230-630	6300-2RS	10mm (0.393)	35mm (1.378)	11mm (0.433)
230-631	6301-2RS	12mm (0.472)	37mm (1.456)	12mm (0.472)
230-632	6302-2RS	15mm (0.590)	42mm (1.653)	13mm (0.511)
230-633	6303-2RS	17mm (0.669)	47mm (1.850)	14mm (0.551)
230-634	6304-2RS	20mm (0.787)	52mm (2.047)	15mm (0.590)
230-636	6306-2RS	30mm (1.181)	72mm (2.834)	19mm (0.748)



WHEEL BEARINGS - High and Low Speed

Part#	Bearing#	ID	OD	Replaces OEM#
215-004	Low - Speed	7/16"	1-1/8"	
215-012	Low - Speed	1/2"	1-1/8"	MTD# 741-0262 / 741-0484
215-020	Low - Speed	1/2"	1-3/8"	
215-053	Low - Speed	9/16"	1-3/8"	
215-038	Low - Speed	5/8"	1-3/8"	
215-046	Low - Speed	3/4"	1-3/8"	
215-061	Heavy - Duty	5/8"	1-3/8"	
215-079	Heavy - Duty	3/4"	1-3/8"	Cub Cadet# 384881-R93 / Snapper# 1-1807 / Toro# 110513, 25-1210



BUSHING - Universal

Part#	O.E.M	Application
215-160	Wheel Reducer	
Wheel Bushing - Nylon Size: 1/2" ID X 5/8" OD X 5/8" Long		
215-178	Wheel Reducer	
Wheel Bushing - Steel Size: 3/8" ID X 1/2" OD X 2-1/4" Long		
215-186	Wheel Reducer	
Wheel Bushing - Steel Size: 7/16" ID X 1/2" OD X 2-1/4" Long		
215-194	Wheel Reducer	
Wheel Bushing - Steel Size: 1/2" ID X 5/8" OD X 3" Long		
215-809	Idler bushing	
Reducer Bushing - Metal Type: Flush. Size: 3/8" ID X .669" OD		
215-805	Idler bushing	
Reducer Bushing - Metal Type: Flush. Size: 1/2" ID X .669" OD		
215-813	Idler bushing	
Reducer Bushing - Metal Type: Offset. Size: 3/8" ID X .669" OD. Flange Height: 5/16"		
215-817	Idler bushing	
Reducer Bushing - Metal Type: Offset. Size: 3/8" ID X .669" OD. Flange Height: 3/4"		
215-801	Idler bushing	
Reducer Bushing - Metal Type: Offset. Size: 1/2" ID X .669" OD. Flange Height: 3/8"		
215-848	Idler bushing (Metal)	
Reducer Bushing - Metal Type: Offset. Size: 1/2" ID X .669" OD. Flange Height: 21/32"		







ARIENS

Part#	O.E.M	Application
215-095	54044 54045 54055	
Tapered roller bearing & race assembly. Intermediate mower drive bearing for 38" (1983 thru 1989) Models 935009, 13, 14 and 20. Worm shaft bearing on some front tine and rear tine Tillers. Impeller shaft bearing on Snowblowers with cast iron gear case Size: 3/4" ID X 1-25/32" OD X 21/32" HT (Bearing# LM11949 and LM11910)		
215-103	05406900 05407000 54069 54070	
Tapered roller bearing and race assembly. Tine shaft bearing on Rear Tine Tillers. Also found on many Front Tine Tillers. Size: 1" ID X 1-31/32" OD X 19/32" HT (Bearing# L44610 & L44643). Fits our 285-203 spindle assembly		
230-276	54080 0540800 05408000	
Fits snowblower model 824; drive support bearing. Size: 1/2" ID X 1-3/8" OD X 7/16" HT (Bearing# 1621-2RS)		
230-300	54063 05406300	
Snowblower input shaft support bearing Models ST424, ST524, ST624, ST732, ST824, ST832, 824, 932 and 1032. Model numbers: 924022, 024, 026, 028, 029, 032, 046, 048, 050, 072, 074, 075 and 079. Also fits John Deere JD9296, bearing for LX172 John Deere. Size: 3/4" ID X 1-3/4" OD X 1/2" HT (Bearing# 1635-2RS and SCO493LU)		
215-214	54093 05409300	
Fits Snowblower model 924. (old style) Carrier shaft bearing. Size: 7/8" ID X 1-3/4" OD X 1/2" HT (Bearing# 8186)		
230-038	54136 / 54177 05413600 05417700	
Axle bearing for snowblower Fits Snowblower model 924. (new style) Size: 1-1/8" ID X 2-3/16" OD X 5/8" HT (Bearing# 8276-1)		
230-036	54182 05418200	
Snowblower Fan bearing. (DOME BEARING). Fits Snowblower model numbers 924084, 924085, 924086, 924087, 924091, 924092, 924313, 924314, 924315 and 924316. Size: 1" ID X 2" OD X .560" HT (Bearing# 8446RS)		









ARIENS continued

Part#	O.E.M	Application
230-003	54039 05403900 05435100	 Spindle Bearing / Drive plate bearing Walk-behind mowers & snowblowers. Jackshaft bearing on 32" & 40". Size: 5/8" ID X 1-3/8" OD X 7/16" HT (Bearing# 99502H / 1623-2RS)
230-029	54123 005412300	 Spindle bearing Size: .787" ID X 1.851" OD X .551" HT (Bearing# 6204-2RS)
230-037	54073 54120 05407300 05412000	 Spindle bearing / PTO bearing On 934000 Tractors > 1989 thru 1995. Model: HT18. Chain case drive shaft bearing on 32" Tiller attachment. Size: 3/4" ID X 1.781" OD X .6075" HT (Bearing# 9504AB / 9504LAB / P204RR6A4362).
230-032	54052 54160 05416000 05405200	 Axle Bearing Snowblower fan bearing on Ariens blowers. Size: 1" ID X 2" OD X 9/16" HT (Bearing# 1641-2RS)
215-200 NEW	05435700	 Wheel Bearing - Sealed both sides. Size: 0.984" (25 mm) ID X 2.046" (52 mm) OD X 0.671" (17mm)" HT. (Also see our 230-102 bearing without retainer clip). (Bearing# 62052RSSNR)
230-007	54137 05413700	 Hex Shaft Bearing For self propelled walk behinds 1982 to present. Comes complete with retainer ring, double seal. Size: 21/32" ID X 1-3/8" OD X 7/16" HT
215-247	54175 / 54176 05417500 05417600	 Wheel Bearing Fits models: LM21, 911016, LM21S, 911017, 911018, 911019, LM21SE, 911020 & LM21SB. (Open back race for grease penetration) Size: 5/8" ID X 1-3/8" OD X 9/16" HT (Bearing# 8419RS)

ARIENS continued

Part#	O.E.M	Application
215-210	54162 036778 05408900 05416200	 Wheel Bearing Fits most 21" walk behind mowers. (Sealed both sides - for open back order our 215-079) Size: 3/4" ID X 1-3/8" OD X 7/16" HT (Bearing# 499502H)
215-557	55028 00550280	 Graphite impregnated bushing. Wheel bushing for Snowblowers. Size: 3/4" ID X 1-1/8" OD X 5/8" HT Flange: 1.325" OD X .108" HT
215-565	55058 05505800	 Graphite impregnated bushing. Wheel bushing for Snowblowers. Also used on many other brands of equipment. Size: 3/4" ID X 1-3/8" OD X 3/4" HT
225-854	55039 05503900	 Bronze flange bushing. Fits on 6 and 7 Hp Snowblower auger shafts, Models 832 and 1032, 20", 24" & 32" snowblowers. Fits 923001, 623004, 923006, 923014, 923017, 923018, 923019, 923020, 923022 & 923023. Size: 3/4" ID X 1" OD X 5/8" HT (Bushing# 8276-1)
780-380	12023 01202300	 Nylon Wheel Retainer. Fits on 20", 24" & 32" Snowblowers. (For use with our 225-854 & 225-862 bushings) Size: 1" ID X 3" L X 2-1/2" W X 31/64" HT. Three 17/64" mounting holes, triangle shape.
225-862	55030 05503000	 Bronze flange bushing. Fits on Snowblower axles / non-differential. Models 824, 24" & 32" snowblower attachment drive train, 910 and 924 non-differential. Size: 7/8" ID X 1" OD X 5/8" HT, Flange: 1-1/4" OD X 1/8" HT
225-839	55035 05503500	 Bronze flange bushing. Fits on Snowblower auger shafts. Models 824, 910, 922 and 924. Size: 1" ID X 1-1/8" OD X 5/8" HT, Flange: 1-1/2" X 1/8"





ARIENS continued

Part#	O.E.M	Application
225-334	55110 05511000	
<p>Bronze flange bushing. Fits on Ariens, snowblowers. Used on many impeller shafts found on Snowblowers. Fits 932 series blowers. Size: 1/2" ID X 3/4" OD X 5/8" HT, Flange: 1"</p>		
225-823	55111 55206 05511100 05520600	
<p>Bronze flange bushing. Front worm shaft bushing on Snowblowers. Size: 1/2" ID X 3/4" OD X 3/4" HT, Flange: 1" X 1/8"</p>		
225-847	55036 05503600	
<p>Nylon flange bushing. Size: 3/8" ID X 1/2" OD X 3/8" HT, Flange: 5/8"</p>		
225-828	55037 05503700	
<p>Nylon Snowblower bushing. Bushing for clutch level. Size: 1/2" ID X 5/8" OD X 5/8" HT, Flange: 3/4"</p>		
225-825	55112 05511200	
<p>Bronze flange bushing Rear worm shaft bushing on Snowblowers. Models 924036, 38, 39, 40, 46, 48, 50, 71, 72 and 924073, also models 832003, 20" and 24" snow attachments; 901011, 20" rear tillers. Size: 3/4" ID X 1" OD X 3/4" HT, Flange: 1-1/4"</p>		
225-826	55122 05512200	
<p>Bronze flange bushing. Fits each side for worm shaft on Snowblowers. Size: 1" ID X 1-1/8" OD X 5/8" HT, Flange: 1-1/2" X 1/8"</p>		
225-822	55026 05502600	
<p>Bronze Snowblower traction bushing. Fits model 924. Size: 5/8" ID X 3/4" OD X 1/2" HT, Flange: 7/8" X 1/8"</p>		
225-850	55022 05502200	
<p>Bronze Snowblower bushing. For model 924; fits Noma and Murray. Size: 7/8" ID X 1-1/8" OD X 5/8" HT, Flange: 1-1/2" X 1/8"</p>		







ARIENS continued

Part#	O.E.M	Application
225-851	55151 55213 55216 05515100 05521600	
<p>Graphite impregnated hexagon bushing. Fits newer Snowblower models: 932026, 932027, 932029, 932302 & 932303. Model ST-524 & ST-724. Size: 3/4" ID X 7/8" OD (Hexagon) X 11/16" HT with flange; Flange OD: 1-3/16"; 7/8" across the flats.</p>		

AYP - Roper / Sears







215-095	1553H 1554H	
<p>Tapered Roller Bearing and Race. Intermediate Ariens mower drive bearing for 38" (1983 thru 1989); Models 935009, 13, 14 and 20. Worm shaft bearing on some Ariens front tine and rear tine tillers. Impeller shaft bearing on Ariens Snowblowers with cast iron gear case. Size: 3/4" ID X 1-25/32" OD X 21/32" HT (Bearing# LM11949 and LM11910)</p>		
230-060	110485 110485X 697H	
<p>Top bearing for our 285-353 quill assembly. Triangle style quill assembly - also fits our 285-031, 285-213 and 285-197 quill assemblies. Fits 93700 series snowblowers Size: .669" ID X 1.578" OD X .475" HT (Bearing# 6203-2RS) Bearing with retainer ring use our Part# 230-274.</p>		
230-029	129895	
<p>Lower bearing for our 285-353 quill assembly. Triangle style quill assembly also used on 38", 42", 44", 46" and 50" cut mowers. Size: .787" ID X 1.851" OD X .551" HT (Bearing# 6204-2RS)</p>		
230-054	175323 Husqvarna# 532 17 53-23	
<p>NEW Bearing with cage assembly For Snowblowers. Fits many manufacturers snowblowers - AYP, Craftsman, Husqvarna and Poulan etc. Bearing ID: .669" ID. Cage measures: 3-5/8" L X 2-5/8" W; Bolt holes are on 2-7/8" centres. (Uses our 230-060 replacement bearing)</p>		

AYP - Roper / Sears continued BOBCAT



Part#	O.E.M	Application
230-747	155066 174284	
Roller Cam Assembly. Fits AYP 42" Decks. Used with our 235-130 shoulder bolt. Size: 1/4" ID X .582" OD X 3/8" HT		
225-078	3736R	
Graphite impregnated flange bushing Flat on one side. Wheel bushing on many rider models. Size: 3/4" ID X 1-1/8" OD X 3/4" HT		
215-145	625J 66507	
Graphite impregnated bushing. Front wheel bushing on many Riders. Models BS1960AR, L1900BR, L1910AR, L1930BT, L1950BR, L1960AR and L1970AR, 1999 & older Size: 3/4" ID X 1-3/8" OD X 5/8" HT		
225-086	64906	
Graphite impregnated bushing. Flat on one side. Size: 5/8" ID X 1-1/8" OD X 3/4" HT		
225-006	9040H 9040HR / 5920H 532 009040	
Graphite impregnated bushing. Wheel bushing - Flat on one side. Models 6A1A1E, 6C1A7E, 6H1A9D, AK12542C and AK125HR38A, also L80000AT, RER80AR & RER80AT, 1999 and older; wheel group. Size: 3/4" ID X 1-3/8" OD X 1" HT		
225-009	126847X 120382X 102792X 120754X / 136847X 120848X / 123848X	
Drag Link bushing. Found on front engine Riders. Size: 3/8" ID X 17/32" OD X 15/32" HT. Flange OD: 11/16" X 1/16"		
225-745	121922X Husqvarna# 532 12 19-32	
King Pin Bushing Located on front axle. Fits models 3363, 1999 and older; 3364, 1991; 9120A29, 1992; CC1236A, CT1036A, CT1236A/B, 1991. Size: 3/4" ID X 13/16" OD X 25/32" HT. Flange OD: 1-1/8		

Part#	O.E.M	Application
215-236	38069N 38042N	
Wheel Bearing Kit Open cage roller bearing with flanged bushings for our Bobcat wheel assembly 175-109. For 32", 36" and 48" mid-sized mowers. Includes: (1) 215-255 roller cage bearing and (2) 225-704 retainer bushings. Size: 5/8" ID X 1-3/8" OD X 1-7/16" bearing cage length or 2-7/16 (between bushing flanges). Overall length with (2) bushings: 2-3/4".		
215-255	Bearing Roller Cage ONLY	
NEW		
Roller Cage Wheel Bearing Fits Bobcat wheel assembly. Size: 5/8" ID X 1-3/8" OD X 1-7/16" Length.		
225-704	Bushing ONLY	
NEW		
Retainer Bushing Used on Bobcat wheel assembly. Size: 5/8" ID X 1-1/2" OD.		
215-238	38273	
Roller Wheel Bearing. Fits 61" cut front casters. Size: .750" ID X 1.125" OD X 2-15/16" Long. (While Quantities Last)		
285-874	33014A 33050	
Yoke Steel Bushing Fits 6" caster wheel support. Size: 3/4" ID X 1" OD X 1-3/4" HT		
230-088		
Heavy duty ball bearing wheel bearing found on Bobcat wheels assemblies. Extended inner race. Size: 1/2" ID X 1-3/8" OD X 1" HT (While Quantities Last)		
215-212	148042	
Heavy duty Wheel bearing. Fits 5-speed units. Size: 1.007" ID X 2.002" OD X .671" HT		
230-056	35062B 35006N	
Output shaft support bearing on 32", 36" and 48" cut decks; extended inner race; includes (2) set screws. Fits variable and 5 speed walk-behind models. Size: 5/8" ID X 1-9/16" OD X 1" HT (Bearing# SB202-10)		







BOBCAT continued

Part#	O.E.M	Application
230-057	65163A 65263A	
<p>Flange plate Used to hold transmission shaft bearings. Fits variable speed models. Use with our 230-056 bearing Size: 1.477" ID</p>		
230-126	38348-01	
<p>Spindle bearing with collar On Bobcat, Cub Cadet, Dixon, Exmark, Grasshopper, Husqvarna, John Deere equipment. Size: 1" ID X 2.046" OD X 1-3/16" overall height with collar. (Bearing# SA205-16, CSA205-16 and RA100RR)</p>		
230-086	35008N	
<p>Spindle Bearing. Size: .987" ID X 2.4375" OD X .670" HT (Bearing# 6305-2RS / 6305-RST) NOTE: For bearing with retainer ring see our 215-199.</p>		
285-957	64163-14 64163-71	
<p>Yoke spacer Size: 3/4" ID X 1-1/4" OD X 1/4" HT</p>		
225-714	48053-2A	
<p>Bronze caster bushing. Fits support arm; fits 8" caster wheel support. Size: 1" ID X 1-1/4" OD X 3/4" HT. Flange: 1-5/8" X 1/8"</p>		
410-308	64163-12 / 303164 Bunton# PLO617 Excore# 363170 Exmark# 303164 Ferris# 154177	
<p>Blade spacer. Size: 5/8" ID X 1" OD X 1/4" HT</p>		



BUNTON

215-210	PO209 PLO941	
<p>Wheel bearing. Fits 410-350-5 caster wheels (For a wheel bearing with an open back race for grease penetration use our 215-079 wheel bearing). Size: 3/4" ID X 1-3/8" OD X 7/16" HT</p>		
230-003	PL4969	
<p>Spindle Bearing Fits new style mowers. Size: 5/8" ID X 1-3/8" OD X 7/16" HT (Bearing# 99502H / 1623-2RS)</p>		



BUNTON continued

Part#	O.E.M	Application
230-086	PL4609 PL4611 Ferris# 1520828 / 1520828S Gravelly# 12984	
<p>Spindle Bearing. Size: .987" ID X 2.4375" OD X .670" HT (Bearing# 6305-2RS / 6305-RST). NOTE: For bearing with retainer ring see our 215-199.</p>		
230-056	PL0878	
<p>Bearing with collar Output shaft / gearbox support bearing on 32", 36" and 48" cut decks; extended inner race; includes (2) set screws. Fits variable speed and 5 speed walk-behind models. Size: 5/8" ID X 1-9/16" OD X 1" HT. (Bearing# SB202-10)</p>		
230-057	PL0832	
<p>Flange plate Used to hold transmission shaft bearings. Fits variable speed models. Use with our 230-056 bearing Size: 1.477" ID</p>		
230-126	PL7323	
<p>Spindle bearing with collar On Bunton, Cub Cadet, Dixon, Exmark, Grasshopper, Husqvarna, John Deere equipment. Size: 1" ID X 2.046" OD X 1-3/16" overall height with collar. (Bearing# SA205-16, CSA205-16 and RA100RR)</p>		
285-957	PLO417	
<p>Yoke spacer. Size: 3/4" ID X 1-1/4" OD X 1/4" HT</p>		
225-706	PLO928 Exmark# 303041 Kees# 363199	
<p>Caster bushing. Fits support arm Size: 7/8" ID X 1-1/8" OD X 1-1/4" HT</p>		





CASE

230-626	C29735	
<p>PTO bearing. For front clutch PTO; fits 200 and 400 series models. Size: 30mm ID (1.181") X 62mm (2.440") OD X 16mm (0.629") Height (Bearing# 6206-2RS)</p>		
230-037	C28971	
<p>Spindle bearing. Size: 3/4" ID X 1.781" OD X .6075" HT (Bearing# 9504AB / 9504LAB / P204RR6A4362)</p>		

CASE continued

Part#	O.E.M	Application
215-210	C12110 C41167	
Wheel bearing - Heavy Duty. Sealed both sides. Size: 3/4" ID X 1-3/8" OD X 7/16" HT (Bearing# 499502H) (Sealed both sides) Note: For open back race for grease penetration see our 215-079.		
215-079	C41167 C42624	
Wheel bearing. Open back race for grease penetration. Size: 3/4" ID X 1-3/8" OD X 17/32" HT. (For a wheel bearing sealed front and back use our 215-210).		

CUB CADET

215-095	651815-R91 (race) 651814-R1 (bearing) 473430-R91 IH-473430R91	
Tapered roller bearing and race. Size: 3/4" ID X 1-25/32" OD X 21/32" HT (Bearing# LM11949 and LM11910)		
230-126	455102-R21 586609-R92 60069-C91 IH60071-C91 IH60071-C92	
Spindle bearing with collar On Cub Cadet models 100, 102, 122 & 123. Size: 1" ID X 2.046" OD X 1-3/16" overall height with collar. (Bearing# SA205-16, CSA205-16 and RA100RR)		
230-029	ST207 SU-9001310-0001	
Spindle bearing Size: .787" ID X 1.851" OD X .551" HT (Bearing# 6204-2RS)		
230-037	465003-R91 470880-R91 IH-470880-R91	
Spindle bearing. Size: 3/4" ID X 1.781" OD X .6075" HT (Bearing# 9504AB / 9504LAB / P204RR6)		
230-274	741-0361	
Transmission input bearing with retainer ring. For models up to 1000 series. Size: .669" ID X 1.574" OD X .471" HT (Bearing# 6203-2Z / 6203ZZNR)		

CUB CADET continued

Part#	O.E.M	Application
215-210	384881-R93 384881-R94	
Wheel bearing - Heavy Duty. Sealed both sides. Size: 3/4" ID X 1-3/8" OD X 7/16" HT		
225-318	490700-R91 748-0867	
Bronze flange bushing. Size: 5/8" ID X 3/4" OD X 3/4" HT Flange: 1"		
225-230 NEW	741-04136 / A / B 941-04136B	
Plastic split hex flange bushing. Used on MTD built front axle of self-propelled mowers with quick wheel height adjuster. Size: 1/2" ID X 3/4" Hex X 7/16" HT. Flange OD: 1" X 1/8" Thick.		

DIXON

230-126	1701	
Spindle bearing with collar Dixon 1701 & 539115279. Fits spindle assy on 30", 42", 50" cut ZTR chain drive (prior to 1999). Also fits wheel hubs on Dixon ZTR with chain drive. . Size: 1" ID X 2.046" OD X 1-3/16" overall height with collar. (Bearing# SA205-16, CSA205-16 and RA100RR)		
230-052	6151	
Spindle Bearing. Size: 3/4" ID X 1-9/16" OD X 15/32" HT (Bearing# 6203-2RS3/4)		
230-037	6011 539125515	
Spindle Bearing. Size: 3/4" ID X 1.781" OD X .6075" HT (Bearing# 9504AB / 9504 LAB)		
215-202	5028 539125206	
High speed bearing, double sealed. Found on Bobcat, Dixie Chopper, Dixon, Hahn-Eclipse, Murray, Scag and Troy Bilt equipment. Sprocket shaft bearing with retainer ring. Fits on many Go-carts and Mini bikes. For bearing without retainer ring order our part# 230-003 Size: 5/8" ID X 1-3/8" OD X 7/16" HT (Bearing# 499502H / 99502H-2RSNR)		
230-049	5249	
Transaxle Bearing. Fits transaxles on ZTR mowers -30" and 42" decks. Models 2301, 3302, 3361, 4421 and 4422. Size: 5/8" ID X 1-9/16" OD X 15/32" HT (Includes Retainer Ring) (Bearing# 6203LU)		









DIXON continued

Part#	O.E.M	Application
215-079	8167 9543	
Wheel Bearing - Heavy Duty. Fits many commercial units. Open back race for grease penetration. Size: 3/4" ID X 1-3/8" OD X .467" HT		

EXMARK

215-220 NEW	Bearing Kit	
Wheel Bearing Kit. Fits midsize mowers with 36", 48", 52", 60" decks. Fits Exmark wheel 1-322154. Fits Turf Ranger, Turf Tracer & Viking metro models from 80000 series and higher. Includes: (1) 215-161 spanner bushing, (1) 215-250 roller cage bearing and (2) 225-730 retainer bushings. Size: 1/2" ID X 1-3/8" OD X 4-21/32" L		
215-250 NEW	Bearing ONLY	
Roller Cage Wheel Bearing Fits midsize mowers with 36", 48" 52", 60" decks. Fits Exmark wheel 1-322154. Size: 49/64" ID X 1-1/4" OD X 3-23/32" L.		
225-730 NEW	Bushing ONLY	
Retainer Bushing Used on Exmark 1-322154 wheel assembly. Size: 3/4" ID X 1-1/2" OD.		
215-161 NEW	51-3547 1513547 Bushing ONLY	
Spanner Bushing Size: 1/2" ID X 3/4" OD X 4-5/8" Length.		
215-163 NEW	63-3579 1-633579	
Spanner Bushing / Spacer Fits Exmark Laser Z; 13 X 500 X 6 wheels. Size: 1/2" ID X 3/4" OD X 5-7/8" Length.		
215-162 NEW	63-3959 1-633959	
Spanner Bushing / Spacer Fits Exmark Laser Z; 13 X 650 X 6 wheels. Size: 1/2" ID X 3/4" OD X 7-1/2" Length.		

EXMARK continued

Part#	O.E.M	Application
215-095	633585 1-633585	
Tapered roller bearing & race Size: 3/4" ID X 1-25/32" OD X 21/32" HT (Bearing# LM11949 X LM11910)		
215-103	25494 543509 1-543509 1-543511	
Tapered roller bearing & race. Size: 1" ID X 1-31/32" OD X 19/32" HT (Bearing# L44610 X L44643)		
230-260	513012 1-513012	
Jackshaft Spindle bearing. Includes locking collar and set screw. Size: .987" ID X 2.046" OD X 1-3/4" HT. (Bearing# HC205-16)		
230-056	303067 1-303067	
Output shaft support bearing. Fits variable speed units, 32", 36" & 48" cut decks; extended inner race; includes (2) set screws. Size: 5/8" ID X 1-9/16" OD X 1" HT (Bearing# SB202-10)		
230-086	303057 / 1-303057 303543 / 1-303543 363173 / 1-363173	
Spindle bearing. Size: .987" ID X 2.4375" OD X .670" HT (Bearing# 6305-2RS / 6305-RST)		
230-233	103-2477	
Spindle bearing. Fits models: many Lazer Z, Lazer HP, Metro Five Speed, Metro HP, Turf Ranger, Turf Tracer HP and Viking Hydro. Size: 1.00" ID X 2.045" OD X .703" HT. (Bearing# CS203ASSY / RA100RR7E8728)		
215-212	323329 1-323329	
Wheel bearing - H.D. Fits Metro models. Size: 1.007" ID X 2.002" OD X .671" HT		
230-241	513009 / 1-513009 631560 / 1-631560	
Wheel bearing H.D. Fits models Explorer and Lazer Z. For front caster wheels (1-1/2" flange OD) Size: 1/2" ID X 1-3/8" OD X 1/2" HT		

EXMARK continued

Part#	O.E.M	Application
225-722	303044 / 1-303044 303514 / 1-303514	 Bottom bushing for caster yoke support arm, Fits models Viking, Explorer, Metro, Turf Ranger and Turf Tracer. Size: 7/8" ID X 1-1/8" OD X 1" HT, Flange OD: 1-1/2"
225-984	513336 1-513336	 Deck support bushing. Fits models Turf Ranger. (Made of nylon) Size: 15/16" ID X 1-1/4" OD X 11/16" HT, Flange OD: 1-5/8"
230-087	109-2064	 Spindle Bearing. Fits spindle / quill assemblies ion Lazer Z XS, Lazer Z air cooled, Lazer Z HP and Lazer Z XS diesel, SN 600,000 and higher. Size: 1.117" ID X 2.166" OD X 1.257" HT.



GRASSHOPPER continued

Part#	O.E.M	Application
230-126	120081	 Spindle bearing with collar Grasshopper 9048, 20444, 6052 & 6061. For 52 & 61" cut. Size: 1" ID X 2.046" OD X 1-3/16" overall height with collar. (Bearing# SA205-16, CSA205-16 and RA100RR)
230-160	122043 122044 Woods# 70345	 Pillow block bearing. Fits 700 and 900 series. Size: 1.004" ID X 5-1/2" L X 2-3/4" HT (Bearing Ref# UC205-16, UCP205-16)
215-247	120050	 Wheel bearing. Fits models 9048, 9052, 9061 and 6372. Tail wheel bearing on Gemini 700 series. Size: 5/8" ID X 1-3/8" OD X 9/16" HT (Bearing# 8419RS)

GILSON

215-095	1044 / 1140 Jacobsen# 500534 / 302009 311959 / 388089 302010 / 311960	 Tapered roller bearing and race. Size: .669" ID X 1.578" OD X .475" HT (Bearing# LM11949 X LM11910)
215-103	1045 1046	 Tapered roller bearing and race. Size: 1" ID X 1-31/32" OD X 19/32" HT (Bearing# L44610 X L44643)
230-060	236544	 Spindle bearing. Size: .669" ID X 1.578" OD X .475" HT (Bearing# 6203-2RS)

GRAVELY

215-103	38199 2124580	 Tapered roller bearing & race Spindle bearing on 36", 40" and 50" mowers. Size: 1" ID X 1-31/32" OD X 19/32" HT (Bearing# L44610 X L44643)
215-184	Fits our 175-125 wheel assembly.	 Wheel Bearing Kit Fits our 175-125 Wheel Assembly and Exmark Wheel# 1-3322154. Also fits Gravely 45205 front caster wheels. Found on 40" and 50" cut mowers. Includes: (1) Roller Cage Bearing, Size: 3/4" ID X 1-11/32" OD X 2-7/16" Overall Length, (2) Retainer Bushings, Size: 3/4" ID X 1-3/8" OD X Flange OD: 1-1/2", Flange Height: 1/8" X Overall Height: 3/8" , (1) Spanner Bushing, Size: 1/2" ID X 3/4" OD X 3-5/16" Overall Length. (Fits our 175-125 wheel assembly).
215-210	11193 36778 37823 540890	 Wheel Bearing. (Sealed both sides) Fits Gravely wheel #37797. Size: 3/4" ID X 1-3/8" OD X 7/16" HT

GRASSHOPPER

230-102	833210 110082 Jacobsen#'s 310427 345050 / 350759	 Spindle bearing Fits models 9544, 9548, 9552, 9561 and 9572. Sealed on one side. Size: .987" ID X 2.045" OD X .591" HT (Bearing# 6205-RS). Two pictures shown for reference
----------------	---	---

GRAVELY continued

Part#	O.E.M	Application
225-851	05521600	
<p>Graghite impregnated hexagon bushing. Fits Sierra series, 4T tractors & snowblowers. Models: 815006-000101, 834034-000101, 836011-000101, 834035-000101, 987103 (GLT584H) & 987107 (GLT584H). Size: 3/4" ID X 7/8" OD (Hexagon) X 11/16" HT with flange; Flange OD: 1-3/16"; 7/8" across the flats.</p>		



HONDA

230-134	96140-60020-10 96150-60020-10 Code# 0876904	
<p>Snowblower friction disc plate bearing. Fits models: HS50, HS70 and HS80. Wheel bearing on most commercial mowers. Size: 15 mm ID X 32mm OD X 9mm HT (Bearing# 6002-2RS)</p>		
230-274	96150-62030-10	
<p>Snowblower fan bearing. Fits models HS624 & HS828. Size: 17mm ID X 40mm OD X 12mm HT or 11/16" ID X 1-5/8" OD X 7/16" HT (Bearing# 6203-2RS / 6203-2Z) (Includes retainer ring)</p>		
230-140	96150-60040-10	
<p>Snowblower auger/ crawler/ trans bearing. Models HS50, HS55, HS70, HS80, HS624 & HS828. Size: 20mm ID X 42mm OD X 12mm HT (Bearing# 6004-2RS)</p>		
230-029	91102-VA4-013 Code# 3175999	
<p>Top crank bearing. Size: .787" ID X 1.851" OD X .551" HT. (Bearing# 6204-2RS)</p>		
230-037	91102-VA4-003 Code# 1688217	
<p>Spindle bearing. Size: 3/4" ID X 1.781" OD X .6075" HT (Bearing# 9504AB / P204RR6)</p>		
230-102	96100-62050-00 91001-ZF1-003 Code# 0636977 Code# 3684248	
<p>Fits engine models GX120, GX160, GX200, GX240, GX270, GX340 & GX390. Size: .987" ID X 2.045" OD X .591" HT (Bearing# 6205 / 6205RS) Two pictures shown for reference.</p>		





HUSQVARNA

Part#	O.E.M	Application
681-173 NEW	Carlton# 37501	
<p>Sprocket Bearing Fits the following Banta Saw sprockets: 99-N27311. Size: 12mm X 13mm X 16mm. Fits crankshaft diameter: 0.472".</p>		
681-176 NEW	Carlton# 21276	
<p>Sprocket Bearing Fits the following Banta Saw sprockets: 99-N30212 and 99-N30213. For some Husqvarna chain saw models: 181, 185, 281, 285, 288, 298, 394, 394XP, 395, 395XP, 1100, 2100 and 2101. Size: 12mm X 12.80mm X 16mm. Fits crankshaft diameter: 0.472".</p>		
230-126	539 10 26-77 539 10 74-06	
<p>Spindle bearing with collar Fits Husqvarna 9048, 52" & 61" cut decks. Size: 1" ID X 2.046" OD X 1-3/16" overall height with collar. (Bearing# SA205-16, CSA205-16 and RA100RR)</p>		
230-060	532 11 04-85	
<p>Spindle Bearing Size: .669" ID X 1.575" OD X .471" HT (Bearing# 6203-2RS / 6203-2DRS-LG) (Top bearing on our 285-353 spindle)</p>		
230-276	606 00 01-84	
<p>Bearing Size: 1/2" ID X 1-3/8" OD X 7/16" HT (Bearing# 1621-2RS)</p>		
230-032	606 00 01-86	
<p>Axle Bearing. Size: 1" ID X 2" OD X 9/16" HT (Bearing# 1641-2RS)</p>		
230-007	606 00 01-85	
<p>Hex Shaft Bearing with retainer ring Size: 21/32" ID X 1-3/8" OD X 7/16" HT (Bearing# 8401-2RS)</p>		
215-247	606 00 01-22	
<p>Wheel Bearing Size: 5/8" ID X 1-3/8" OD X 9/16" HT (Bearing# 8419RS)</p>		

HUSQVARNA continued

Part#	O.E.M	Application
230-054 NEW	532 17 53-23	
Bearing with cage assembly For Snowblowers. Fits many manufacturers snowblowers - AYP, Craftsman, Husqvarna and Poulan etc. Bearing ID: .669" ID. Cage measures: 3-5/8" L X 2-5/8" W; Bolt holes are on 2-7/8" centres. (Uses our 230-060 replacement bearing)		
225-722	539 10 12-32	
Bushing. Size: 7/8" ID X 1-1/8" OD X 1" HT; Flange OD 1-1/2"		

JOHN DEERE

215-236	PT8870	
Wheel Bearing Kit Open cage roller bearing with flanged bushings for our wheel assembly 175-109. For 32", 36" and 48" mid-sized mowers. Includes: (1) 215-255 roller cage bearing and (2) 225-704 retainer bushings. Size: 5/8" ID X 1-3/8" OD X 1-7/16" bearing cage length or 2-7/16 (between bushing flanges). Overall length with (2) bushings: 2-3/4".		
215-255 NEW	Bearing Roller Cage ONLY	
Roller Cage Wheel Bearing Size: 5/8" ID X 1-3/8" OD X 1-7/16" Length.		
225-704 NEW	Bushing ONLY	
Retainer Bushing Size: 5/8" ID X 1-1/2" OD.		
230-409	M42786 M74707	
Deck bearing for double pulley assembly. Fits 38", 39", 46" and 47" decks. Size: 30mm barrel dia. X 5/8" shaft dia. X 1-9/16" L Overall Length: 3-1/8"		
215-095	8188 / 8226 AM122120 JD8188 JD8226 M124324	
Tapered roller bearing and race. For models 2243, 2653, 3215, 3225, 3235 and 3365. Size: 3/4" ID X 1-25/32" OD X 21/32" HT (Bearing# LM11949 & LM11910)		

JOHN DEERE continued

Part#	O.E.M	Application
215-103	JD8253 JD8933	
Tapered roller bearing & race. Fits models 303, 305, 500 & 1500 tillers, 46"-50" snowblowers, 51" rotary brooms. Size: 1" ID X 1-31/32" OD X 19/32" HT (Bearing# L44610 & L44643)		
215-015	JD8187 JD8225	
Tapered roller bearing and race. For models 2243, 3325, 3365, 365, 855 and 955; for tine shaft. Size: 1-1/4" ID X 2-21/64" OD X 21/32" HT (Bearing# LM67048 & LM67010)		
230-126	8597 JD8597	
Spindle bearing with collar Fits John Deere 300-317 hydrostatic tractors, M653 - M655 Z Track. Size: 1" ID X 2.046" OD X 1-3/16" overall height with collar. (Bearing# SA205-16, CSA205-16 and RA100RR)		
230-102	M63810 M88251	
Spindle bearing Fits on all 60" decks - 400 series and 72" - 900 series. 160, 260, 261 & 272 mowers; 359 snowblower. Size: .987" ID X 2.045" OD X .591" HT (Bearing# 6205-RS) Two pictures shown for reference.		
230-037	9239 / 9266 / 9296 JD9239 / JD9296	
Spindle bearing. Fits mowers up to 48" cut, prior to 1988. Size: 3/4" ID X 1.781" OD X .6075" HT (Bearing# 9504AB / P204RR6)		
230-003	M47144 PT8891 AM122119 JD9266 / JD8570	
Edger shaft bearing. For models #2, #3 and 3K edgers. Size: 5/8" ID X 1-3/8" OD X 7/16" HT (Bearing# 99502H / 1623-2RS)		
230-086	M77534 JD9299 JD9467	
Spindle bearing Fits models PC2003, 32" - 52" commercial walk behinds. Size: .987" ID X 2.4375" OD X .670" HT (Bearing# 6305-2RS / 6305-RST)		

JOHN DEERE continued









Part#	O.E.M	Application
230-060	GX20818 JD8535	
<p>Spindle Bearing. Fits models F710 and F725. Size: .669" ID X 1.575" OD X .475" HT (Bearing# 6203-2RS)</p>		
230-069 NEW	AA21480 Toro / Wheel Horse# 1089017 / 934237	
<p>Bearing Fits John Deere 600 series Quik-Trak, 600, 700, Z800 and Z900 Z-Trak mowers, Size: .630" ID X 1.780" OD X .735" overall HT. (Bearing# SX164518CL8) Top and bottom pictures shown (1) bearing</p>		
215-210	AM35443 AM118315 AM127304	
<p>Wheel Bearing. Fits models 100 and LX series; 410-350-5 caster wheel; bearing is sealed on both side. Size: 3/4" ID X 1-3/8" OD X 7/16" HT</p>		
215-212	AM102605 AM33797	
<p>Wheel Bearing - H.D. Fits models 110, 112, 140, 200, 312, 314, 316, 317, 318, 420 & 430 series. Size: 1.007" ID X 2.002" OD X .671" HT</p>		
215-247	PT8894	
<p>Wheel Bearing Fits models: PC2003; 32" thru 52" commercial walk behinds. Size: 5/8" ID X 1-3/8" OD X 9/16" HT (Bearing# 8419RS)</p>		
230-276	AM122108	
<p>Bearing - Fits models 524D, 724D, 826D and 1032 walk behinds and snowblowers. Size: 1/2" ID X 1-3/8" OD X 7/16" HT (Bearing# 1621-2RS)</p>		
230-300	AM122158	
<p>Bearing. Size: 3/4" ID X 1-3/4" OD X 1/2" HT (Bearing# 1635-2RS)</p>		
215-214	AM122117	
<p>Carrier Shaft Bearing. Size: 7/8" ID X 1-3/4" OD X 1/2" HT (Bearing# 8186)</p>		

JOHN DEERE continued

Part#	O.E.M	Application
215-200 NEW	AM102888 AM131046 AM137758	
<p>Wheel Bearing - Sealed both sides. Fits John Deere models: 240, 245, 260, 265, 285, 318, 320, 322, 325, 330, 332, 345, 420, 425, 430, 445, 455, 715, GT225, GT235, GT235E, GT242, GT245, GT262, GT275, GX325, GX335, GX345, GX355, X465, X475, X485, X485SE, X495, X700, X720, X720SE, X724, X740, X744, X530, X534, X540, F910 rear wheel - serial# ranges 360, 102 thru 750,000 & 010,001 - 100,000, F930 rear wheel - serial# range 360,121 - 750,000, F915 rear wheel, F925 rear wheel, F935 rear wheel - serial# ranges 360, 361 - 750,000 & 010,001 - 190,000, F912 rear wheel, F932 rear wheel, F911 rear wheel, F710 rear wheel, F725 rear wheel, F735 rear wheel, 1420 rear wheel, 1435 rear wheel, 1445 rear wheel, Z225, Z425, Z445, Z465, Z245, Z510A, Z520A. Size: 0.984" (25 mm) ID X 2.046" (52 mm) OD X 0.671" (17mm)" HT. (Also see our 230-102 bearing without retainer clip). (Bearing# 62052RSSNR)</p>		
230-038	AM122105	
<p>Axle Bearing. Size: 1-1/8" ID X 2-3/16" OD X 5/8" HT (Bearing# 8276-1)</p>		
215-250 NEW	Bearing only	
<p>Roller Cage Wheel Bearing ONLY. Fits Exmark midsize mowers with 36", 48" 52", 60" decks. Fits Exmark wheel 1-322154. Size: 49/64" ID X 1-1/4" OD X 3-23/32" L</p>		
780-580 NEW	AM119482	
<p>Impeller Bearing Housing only For John Deere, Murray / Noma snowblowers. Found on John Deere snowblower model 826 etc. (Made of Aluminum). Size: 1-1/4" ID X 7/8" Overall Height. (3) 5/16" Mounting holes on 2.35" centers. (Uses our 225-677 Bronze Bushing in many applications).</p>		
230-056	PT8767	
<p>Output shaft support bearing. Fits variable speed units, extended inner race; includes (2) set screws. Size: 5/8" ID X 1-9/16" OD X 1" HT (Bearing# SB202-10)</p>		
225-334	M127164	
<p>Bronze Flange Bushing Noma and Murray Size: 1/2" ID X 3/4" OD X 5/8" HT, Flange: 1"</p>		

JOHN DEERE continued

JONSEREDS

Part#	O.E.M	Application
225-825	M127538	
<p>Bronze flange bushing. Rear worm shaft bushing on Ariens and John Deere Snowblowers. Models 924036, 38, 39, 40, 46, 48, 50, 71, 72 and 924073, also models 832003, 20" and 24" snow attachments; 901011 20" rear tillers. Size: 3/4" ID X 1" OD X 3/4" HT, Flange: 1-1/4".</p>		
225-839	M124417	
<p>Bronze flange bushing Fits models 828D, 924DE, 1032D, 1128DE, 1128DDE & 1332DDE walk behind snowblowers. Size: 1" ID X 1-1/8" OD X 5/8", Flange: 1-1/2" X 1/8"</p>		
225-854	M127082	
<p>Bronze flange bushing Fits 524D, 724D (PC2569), and 826D (PC2570) walk behind snowblowers. Size: 3/4" ID X 1" OD X 5/8" (Bushing# 8276-1)</p>		
225-851	M127093	
<p>Graphite impregnated hexagon bushing Size: 3/4" ID X 7/8" OD (Hexagon) X 11/16" HT with flange; Flange OD: 1-3/16"; 7/8" across the flats.</p>		
225-320	M83541 Bunton# PJH1060	
<p>Caster bushing. Fits all mid-size hydro & belt driven mowers. Size: 1" ID X 1-1/4" OD X 1" HT; Flange OD: 1-3/4"</p>		
215-557	M41522 E16522	
<p>Wheel bushing Fits 65, 66 and 68 series riders, 8, 50 and 80 series dump carts, arm bushing for 50" cut models 160 & 260 rear mount 3 pt. hitch mowers. Size: 3/4" ID X 1-1/8" OD X 5/8" HT Flange: 1.325" OD X .108" HT</p>		
285-957	PT8886	
<p>Yoke spacer found on early 32", 36", 48" and 52" mowers with 6" wheel assembly. Size: 3/4" ID X 1-1/4" OD X 1/4" HT</p>		
225-319	GX21994	
<p>NEW Nylon Steering Shaft bushing For John Deere. Found on L100 series mowers. Size: 5/8" ID X .900" OD X 7/8" overall HT; Flange OD: 1.08"</p>		

Part#	O.E.M	Application
681-173	Carlton# 37501	
<p>NEW Sprocket Bearing Fits the following Banta Saw sprockets: 99-N27311. For some Jonsereds chain saw models: 2065, 2071, 2095 and 2165. Size: 12mm X 13mm X 16mm. Fits crankshaft diameter: 0.472".</p>		
681-176	Carlton# 21276	
<p>NEW Sprocket Bearing Fits the following Banta Saw sprockets: 99-N30212 and 99-N30213. For some Husqvarna chain saw models: 181, 185, 281, 285, 288, 298, 394, 394XP, 395, 395XP, 1100, 2100 and 2101. Size: 12mm X 12.80mm X 16mm. Fits crankshaft diameter: 0.472".</p>		
592-106	738 22 02-25	
<p>Crankshaft Bearing Clutch and flywheel side. Size: 37/64" ID X 1-3/8" OD X 7/16" HT (Bearing# 6202 - open both sides)</p>		

KAWASAKI

230-102	92045-1163 92045-1229	
<p>Bearing Size: .987" ID X 2.045" OD X .591" HT (Bearing# 6205-RS) Sealed one side Two pictures shown for reference.</p>		

KUBOTA

230-102	08101-06205	
<p>Bearing For 44", 48", 54" and 60" decks - gear box Size: .987" ID X 2.045" OD X .591" HT (Bearing# 6205-RS) Sealed one side Two pictures shown for reference.</p>		
230-029	08101-06204	
<p>Spindle Bearing Size: .787" ID X 1.851" OD X .551" HT (Bearing# 6204-2RS)</p>		

K & S TRIM - ALL

225-268	620022 70616274	
<p>Eager Shaft Bearing Size: .394" ID X 1.181" OD X .454" HT (Bearing# 6200ZZ)</p>		

K & S TRIM - ALL cont.

Part#	O.E.M	Application
225-276	K&S Bushing	
Bronze Flange Bushing Fits on Edgers. Size: 1/2" ID X 3/4" OD X 3/4" HT		

LAWN BOY

225-284	681904 678782	
Axle bushing. Used on Lawn Boy self propelled mowers. Size: 1/2" ID X 7/8" OD X 7/8" HT		

215-095	700417 700418	
Tapered roller bearing & race. For Tiller gearboxes. Size: 3/4" ID X 1-25/32" OD X 21/32" HT (Bearing# LM11949 & LM11910)		

215-103	703809 703210	
Tapered roller bearing & race. For Tiller gearboxes. Size: 1" ID X 1-31/32" OD X 19/32" HT (Bearing# L44610 & L44643)		

230-060	236544 700479 703275	
Spindle bearing Size: .669" ID X 1.578" OD X .475" HT (Bearing# 6203-2DRS-LG)		

225-102	681832	
Lower main needle bearing Size: 1-1/8" ID X 1-3/8" OD X 5/8" HT		

225-375	681375 681831	
Lower main bearing "F" series self-propelled Size: 7/8" ID X 1-1/8" OD X 3/4" HT (Bearing# FC65771)		

MERRY TILLER 343

225-615	343 706-0343	
Needle bearing Fits most Tillers, requires 2 per unit Size: 1-1/4" ID X 1-1/2" OD X 1" HT		

MTD

Part#	O.E.M	Application
230-060	741-0124 741-0563 / 741-0600 941-0124 / 941-0600	
Spindle bearing Fits models 074, 084, 114, 314 series. Size: .669" ID X 1.578" OD X .475" HT (Bearing# 6203-2RS)		

230-114	741-0132	
Spindle bearing Size: 3/4" ID X 2" OD X 9/16" HT (Bearing# 1638-2RS)		

230-003	741-0155 941-0155	
Spindle bearing Fits models 700, 719, 730, 740, 756, 766, 020, 030, 406, 430 series. Size: 5/8" ID X 1-3/8" OD X 7/16" HT (Bearing# 99502H / 1623-2RS)		

230-011	741-0524 941-0524 741-0524P	
Spindle Bearing Size: .625" ID X 1.575" OD X .475" HT (Bearing# 6203-2DRS-LG / 6203RST-5/8)		







230-029	741-0919 941-0919 741-0919P	
Spindle bearing Models 491, 831, 832 & 930 series snowblowers; also works with our 225-052 bearing retainer plate. Size: .787" ID X 1.851" OD X .551" HT (Bearing# 6204-2RS)		

230-276	741-0133	
Spindle bearing Models 824, 840, 850 & 960 series. Size: 1/2" ID X 1-3/8" OD X 7/16" HT (Bearing# 1621-2RS)		









230-274	741-0563 941-0563 741-0361	
Snowblower auger bearing with retainer ring. Fits 400 thru 700 series snowblowers. Size: .669" ID X 1.574" OD X .471" HT (Bearing# 6203-2Z)		

230-094	741-0161	
Spindle bearing with retainer ring. Size: .787" ID X 1.850" OD X .551" HT (Bearing# 6204NSL / 62042RSNR)		







MTD continued

Part#	O.E.M	Application
230-270 NEW	741-04076	
Bearing with Retainer ring For MTD built equipment. Found on MTD snowblower models: 31AH5ZLH704 (2008), 31AE5KLF795 (2006 -07), 31AE5KLF304 (2006), 31AE5KLF372 (2006), 31AE5KLF401 (2006), 31AE5KLF720 (2006), 31AE5MLH795 (2007) & 31AE5MLG729 (9 Hp MTD / Troy Bilt blowers) Size: 9/16" (.5625") ID X 1-3/3" (1.375") OD X 7/16" (.4375") HT. (Bearing# 1622-2RS)		
230-002	741-0309 741-0310 941-0309 941-0310	
Snowblower axle bearing also fan bearing for snowblowers - self aligning. Fits 22" thru 40" blowers. Snowblower axle bearing. Fits 20" thru 24" & 36 thru 40" Snowblowers Size: 3/4" ID X 1.850" OD X 1-3/16" overall height with collar.		
230-250	741-0185 741-04024 941-0185	
Snowblower drive axle bearing Models 310-230 thru 310-960 snowblowers; 800 & 900 series snowblowers. Size: 7/8" ID X 2-1/32" OD X 1-1/16" HT w/collar (Bearing# SB205-14)		
225-104	741-0404 741-0136 941-0404	
Needle bearing for variable speed pulleys. Models 600 & 659, also found on White and Yardman. Size: 9/16" ID X 3/4" OD X 9/16" HT		
215-247	741-0569 941-0569	
Wheel bearing Flanged wheel bearing single seal Size: 5/8" ID X 1-3/8" OD X 9/16" HT (Bearing# 8419RS)		
225-045	748-0110 948-0110	
Bronze flange bushing Fits models 553, 685 and 689 series leaf vacuums and power vacuums; 31245S, 31550S (1985) and 225 (1988-1989) Size: 5/8" ID X 7/8" OD X 5/8" HT, Flange: 1-1/8" OD		
225-282	741-0305	
Bronze bushing Size: .630" ID X .720" OD X .720" HT		

MTD continued

Part#	O.E.M	Application
225-572	741-0340	
Bearing Sleeve for MTD Fits 600 series models, also fits 1985 thru 1987 MTD Rider models 1 35-137 w/ single speed transaxle. Size: 3/4" ID X 1" OD X 1" HT		
225-532	741-0225 941-0225	
Plastic king pin bushing - 6 sided Fits 38" and 42" cut front engine riders. Models 13B5560B000, 13B5. Size: 5/8" ID X 7/8" OD X 5/8" HT, Flange: 1-1/8" X 1/8"		
225-122	741-0324 941-0324	
Nylon flange bushing. Fits self-propelled mowers. Size: 1/2" ID X 11/16" OD X 19/32" HT		
225-169	741-0313 741-0487 741-0487A 941-0487A	
Nylon flange wheel bushing. Same as below but 1/8" shorter. Size: 5/8" ID X 13/16" OD X 7/8" HT, Flange: 1-1/8"		
225-750	741-0487	
Nylon flange bushing. Fits MTD riders 400, 600 and 700 series Lawn Tractors. Size: 5/8" ID X 13/16" OD X 1" HT Flange: 1-1/8"		
225-334	748-0108 741-0248 948-0108	
Bronze flange bushing Fits impeller shafts found on Snowblowers. Models 610, 612, 640, 642 & 660 Size: 1/2" ID X 3/4" OD X 5/8" HT, Flange: 1"		
225-128	748-0227 748-0227A 748-0229 948-0227A	
Bronze hex nut flange bushing. Fits Tiller models 020 and 030 - 6 sided Size: 5/8" ID X 7/8" OD X 5/8" HT, Flange: 1-1/8"		
225-534 NEW	741-0245	
Wheel Shaft Bushing Plastic hexagon bushing, found on MTD built equipment. Size: 3/4" ID X 1-1/16" OD (Hexagon) X 3/4" HT with flange; Flange OD: 1-1/4"; 1" across the flats.		









MTD continued

Part#	O.E.M	Application
225-538 NEW	741-0598 941-0598 Cub Cadet# 7410598 Troy Bilt# 9410598	
<p>Flange Bushing Bronze hexagon bushing, found on MTD built equipment. Size: 3/4" ID X 1-1/4" OD (Hexagon) X 3/4" HT with flange; Flange OD: 1-3/8"; 1-1/8" across the flats.</p>		
225-136	748-0146	
<p>Graphite impregnated flange bushing Size: 5/8" ID X 1-3/8" OD X 17/32" HT. Flange: 1-1/2"</p>		
225-173	748-0169 948-0169	
<p>Graphite impregnated bushing Size: 3/4" ID X 1" OD X 1-15/16" HT. Flange OD: 1-1/8"</p>		
225-167	741-0662 741-0376 941-0376	
<p>Bronze flange bushing Fan bushing (rear); Impeller shaft bushing - auger gear box, 400-600 series 1994-2004. Size: 3/4" ID X 1" OD X 5/8" HT; Flange OD: 1-1/2"</p>		
225-110	748-0184	
<p>Bronze flange bushing Front wheel bushing on riders, also fits Tiller models 375, 380, 405, 410 and snowblower models 440, 450, 550, 552, 586, 588, 840, 841 & 850. Size: 5/8" ID X 3/4" OD X 3/4" HT, Flange OD: 1-1/8"</p>		
225-300	748-0855	
<p>Bronze flange bushing Fits Tiller model 766 and others. Size: 5/8" ID X 3/4" OD X 1" HT; Flange OD: 1-1/4"</p>		
225-318	748-0867	
<p>Bronze flange bushing for MTD. Fits all 700 series transmissions 3 & 5 speed output shaft. Also fits 800 & 900 series transaxles. Oil impregnated, bronze. Foote model 2010. Size: 5/8" ID X 3/4" OD X 3/4" HT Flange OD: 1"</p>		

MTD continued

Part#	O.E.M	Application
225-170 NEW	741-0339 941-0339 Cub Cadet# 7410339 Cub Cadet# 9410339 Troy Bilt# 7410339 Troy Bilt# 9410339	
<p>Bronze flange bushing For MTD. Found in MTD 400, 500 and 600 series. 600 series (1992 thru 1993) and 400, 500 and 600 series (1994 thru 2004). Size: 3/4" ID X 1" OD X 1" HT including flange, Flange OD: 1-1/8".</p>		
225-129	741-0656 741-0656A 941-0656A	
<p>Steering Bushing Fits all Cub Cadet LT series mowers. Models: LT1018, LT1024, LT1022, LT1018LE, LT1040, LT1042, LT1045, LT1046, LT1050) plus many models of White, MTD, Yard Machine, Yard Man and Troy Bilt. Size: 5/8" ID X 7/8" OD X 1/4" HT</p>		
225-230 NEW	741-04136 741-04136A 741-04136B 941-04136B	
<p>Plastic split hex flange bushing. Used on MTD built front axle of self-propelled mowers with quick wheel height adjuster. Size: 1/2" ID X 3/4" Hex X 7/16" HT. Flange OD: 1" X 1/8" Thick.</p>		
225-144	748-0143 741-0293 941-0293	
<p>Plastic flange bushing Fits 300, 400, 500 series lawn tractors and 450, 550, 552, 586 and 588 (1987-1988) series snowblowers. Size: 3/4" ID X 1" OD X 3/4" HT Flange OD: 1-1/4"</p>		
225-754	741-0660 941-0660 741-0660A	
<p>Plastic flange bushing Fits all garden tractors except 1995 units. Size: .755" ID X .940" OD X .980" HT</p>		
225-235	741-0199 741-0490 748-0151 941-0490	
<p>Plastic flange bushing Fits models 311-100A, 311-430A, 311-600A, 450, 550 and 580 snowblowers. Size: 3/4" ID X 1-1/4" OD X 3/4" HT; Flange OD: 1-3/8". Measures: 15/16" across the flats</p>		



MTD continued

Part#	O.E.M	Application
225-175	731-0374 AF43632	
<p>Plastic King pin flange bushing Lower chain case bushing on model 406 rear tine tiller, also found on front tine tillers - 5 and 8 Hp. Size: 1" ID X 1-1/4" OD X 1" HT; Flange OD: 1-1/2"</p>		
225-314	741-0300 941-0300	
<p>Plastic flange bushing Fits many MTD Snowblowers. Size: 3/4" ID X 1-1/2" OD X 3/4" HT Flange OD: 1-3/4", Measures: 1-1/4" across the flats</p>		
225-280	741-0170 741-0244 / 941-0244 741-0192 / 941-0192	
<p>Graphite impregnated bushing Size: 1" ID X 1-1/2" OD X 3/4" HT. Flange OD: 1-3/4" Measures 1.245" across the flats</p>		
225-238	741-0523 941-0523	
<p>Plastic flange bushing Size: 3/4" ID X 1-1/16" OD X 15/16" HT. Flange OD: 1-3/8"</p>		
225-240	741-0659 941-0659	
<p>Plastic flange bushing Fits pivot bars on most lawn tractors. Size: 5/8" ID X 31/32" OD X 1" HT. Flange OD: 1-1/4"</p>		
225-132 NEW	741-0475 941-0475	
<p>Plastic Flange Bushing Found on MTD riders on steering and on snow blower auger and chute assemblies. Size: 3/8" ID X 1/2" OD X 3/8" HT. Flange OD: 5/8" X 3/32" thick.</p>		
225-536 NEW	741-0493A	
<p>Plastic Auger Bushing. Found on MTD built equipment / blowers. Size: 13/16" ID X 7/8" OD X 5/8" HT. Flange OD: 1-1/16".</p>		
285-153	922-0153	
<p>Engine mount bushing for MTD. Fits 600 series riders. Made of Nylon. Size: 1/2" ID X 1-1/8" OD X 1/4" HT</p>		

MTD continued

Part#	O.E.M	Application
225-160	741-0661 741-0661A	
<p>Graphite Impregnated flange bushing for MTD. Auger shaft bushing in snowblower gearbox. Found in models: 400, 500 & 600 series. (2004, 2005). Size: .754" ID X 1" OD X .925" HT, Flange OD: 1-1/4"</p>		
225-674	741-0217	
<p>Bronze Bushing / Bearing Sleeve For MTD. Fan bushing (front / rear) found in snowblowers made by MTD. Fits 600 thru 900 series snowblowers. Size: 7/8" ID X 1-1/8" OD X 1" HT</p>		
225-056	741-0706 941-0706	
<p>Wheel bushing for MTD lawn & garden equipment. Comes with a plastic zerk / grease fitting. Size: .625" or 5/8" ID X .812" or 13/16" OD X 1" overall height. Shoulder / Flange OD: 1-1/4"</p>		
225-057	741-0990A	
<p>Wheel bushing for MTD lawn & garden equipment. Comes with a plastic zerk / grease fitting. Size: 3/4" ID X 1" OD X 1-3/8" overall height. Shoulder OD: 1-1/8"</p>		
225-673 NEW	741-0401 Cub Cadet# 7410401 Murray# 585581 Noma# 578572	
<p>Plastic wheel bushing For MTD. Used to reduce wheels from 7/8" to 3/4" inside diameter. Size: 3/4" ID X 7/8" OD X 1" HT</p>		







MURRAY

230-003	99502H MJ49562	
<p>Spindle Bearing Murray walk-behind mowers & blowers. Jackshaft bearing on 32" & 40"; Lower bearing on 285-292 / 300 Murray quills. Noma snowblowers 1994 & newer. Size: 5/8" ID X 1-3/8" OD X 7/16" HT (Bearing# 99502H / 1623-2RS).</p>		
230-011	2055	
<p>Spindle bearing Found on MTD. Upper bearing for our part# 285-300 and 285-292 quill assembly for Murray, for the lower bearing use our part# 230-003. Size: .625" ID X 1.575" OD X .475" HT (Bearing# 6203-2DRS-LG-10 / 6203RST-5/8)</p>		

MURRAY continued

Part#	O.E.M	Application
230-029	55541	
<p>Spindle bearing Size: .787" ID X 1.851" OD X .551" HT (Bearing# 6204-2RS)</p>		
230-060	12325MA 1255MA 1501389MA 49562MA 782973MA	
<p>Top bearing for our 285-353 quill assy, fits our 285-031, 285-213, 285-221 & 285-197 quill assy. Fits Murray / Noma 39" & 40" models. Bearing with retainer ring use our Part# 230-274. Size: .669" ID X 1.578" OD X .475" HT (Bearing# 6203-2RS)</p>		
225-470 NEW	MJ780073 Noma# 50673	
<p>Needle bearing For Murray / Noma snowblowers. Found on models: 826, 1026 and 1032. Size: 3/4" (.750") ID X 1" OD X 3/4" (.750") HT. (Taller version of our 225-466).</p>		
215-311	Murray Quill Repair Kit	
<p>Bearings and Spacer kit Fits our 285-292 & 285-300 quill assemblies. Includes: (1) 230-003 (Bearing# 99502H / 1623-2RS) (1) 230-011 (Bearing# 6203-2RS) (1) 285-171 (Murray# 91902) Spacer bushing</p>		
230-267	780048 761507	
<p>Bearing only for our 230-265 Fits on many Snowblower models - including Noma. Size: 7/8" ID X 2" OD X 9/16" HT. Keyway: .200"</p>		
230-265	780048 761507 MJ761507	
<p>Bearing with cage assembly for Snowblowers. Bearing ID: 7/8" ID with .200" keyway (included) Cage Size: 3-3/4" L X 2-3/4" W. Bolt holes are on 3" centres</p>		
230-262 NEW	334163 Noma# 1413 Swisher# 334163	
<p>Bearing with cage assembly For Snowblowers. Fits many manufacturers snowblowers - Murray / Noma / Canadiana, Sears / Craftsman, Swisher etc. Self-Aligning Bronze Bushing ID: 7/16" X 1/2" HT. (2) 5/16-18" threaded mounting holes on 1-3/4" centers</p>		

MURRAY continued

Part#	O.E.M	Application
780-580 NEW	579726 579726MA	
<p>Impeller Bearing Housing only For John Deere, Murray / Noma snowblowers. Found on John Deere snowblower model 826 etc. (Made of Aluminum). Size: 1-1/4" ID X 7/8" Overall Height. (3) 5/16" Mounting holes on 2.35" centers. (Uses our 225-677 Bronze Bushing in many applications).</p>		
215-152	20048	
<p>Bronze axle bushing Fits self-propelled mowers. Size: 5/8" ID X 13/16" OD X 1-1/4" HT (While Quantities Last)</p>		
285-742	24533 24533Z	
<p>Spacer bushing Used on many manufacturers jackshafts Size: 5/8" ID X 13/16" OD X 1/2" HT (Priced individually) (Sold in multiples of 5)</p>		
285-171	91903 24532	
<p>Spacer bushing for Murray quill. Fits our 285-300, 285-292 and 285-304 quills. Size: 5/8" ID X 7/8" OD X 1-3/4" HT (Sold in multiples of 5)</p>		
225-150 NEW	53731 53731MA Noma# 53731 Noma# 53731MA Swisher# 53731 Swisher# 53731MA	
<p>Bronze Bushing / Bearing Sleeve For Murray / Noma / Canadiana. Impeller shaft bushing / bearing sleeve. Found on many Sears / Craftsman Dual Stage snowblowers. Models 536-888110 etc. Size: 3/4" ID X 7/8" OD X 3/4" HT.</p>		
225-078	403010	
<p>Graphite impregnated flange bushing. Flat on one side. Wheel bushing on many rider models. Size: 3/4" ID X 1-1/8" OD X 3/4" HT</p>		
225-075	52407	
<p>Steel Wheel Bushing found on many Murray riders. Bushing has two flat spots. Size: 3/4" ID X 1" OD X 3/4" HT; Flange OD: 1-3/8" Measures: 15/16" across the two flats</p>		







MURRAY continued







NOMA - AMF / Canadiana / Dynamark

Part#	O.E.M	Application
225-148	90035	
Plastic flange bushing Front axle bushing on pre 1991 Tractors. Size: 3/4" ID X 7/8" OD X 11/16" HT		
215-565	403056	
Graphite impregnated bushing Wheel bushing on many Riders. Size: 3/4" ID X 1-3/8" OD X 3/4" HT		
225-154	56105 24368	
Plastic flange bushing Wheel bushing found on Murray Riders. Size: 5/8" ID X 1-3/8" OD X 45/64" HT		
225-146	91334 24367 491334	
Plastic flange bushing Wheel bushing found on Murray Tractors. Size: 3/4" ID X 1-3/8" OD X 1" HT. Flange OD: 1-1/2"		
225-152	93064	
Plastic flange wheel bushing Fits 18 Hp lawn and garden tractor model 46371X92A. Size: 7/8" ID X 1-3/8" OD X 1" HT		
225-673 NEW	741-0401 Cub Cadet# 7410401 Murray# 585581 Noma# 578572	
Plastic wheel bushing For MTD. Used to reduce wheels from 7/8" to 3/4" inside diameter. Size: 3/4" ID X 7/8" OD X 1" HT		
230-268 NEW	780013 780013MA 85504 85504MA Noma# 85504	
Bushing with cage assembly For Murray / Noma / Canadiana Snowblowers. Bushing ID: 1/2" ID X 3/4" OD. Cage measures: 2-1/2" X 2" W. (Uses our 225-334 bushing - included).		
225-334	MJ85504	
Bronze Flange Bushing Noma and Murray Size: 1/2" ID X 3/4" OD X 5/8" HT Flange: 1"		



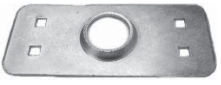



Part#	O.E.M	Application
230-060	49562	
Spindle bearing Fits our 285-221 quill assembly (2) per quill. Size: .669" ID X 1.578" OD X .475" HT (Bearing# 6203-2DRS-LG / 6203-2RS)		
230-265	9648	
Bearing with cage assembly for Snowblowers. Bearing ID: 7/8" ID with .200" keyway (included) Cage measures: 3-3/4" L X 2-3/4" W; Bolt holes are on 3" centres. (Uses our 230-267 replacement bearing)		
230-267	9648	
Bearing only for our 230-265 Fits on many Snowblower models. Size: 7/8" ID X 2" OD X 9/16" HT. Keyway: .200"		
230-034	85087	
Bearing - Snowblower Size: 7/8" ID X 2" OD X 9/16" HT. (Bearing# 1640-2RS)		
230-032	85086	
Bearing - Snowblower Size: 1" ID X 2" OD X 9/16" HT (Bearing# 1641-2RS)		
230-006	579863	
Bearing - Snowblower Models N1030DEL and N1232DEL. Size: 12mm ID X 28mm OD X 8mm HT Size: .472" ID X 1.102" OD X .315" HT (Bearing# 6001-2RS)		
230-003	580781	
Bearing - Snowblower Fits newer model 1994 and newer. Size: 5/8" ID X 1-3/8" OD X 7/16" HT (Bearing# 1623-2RS / 99502H)		
225-470 NEW	50673 Murray# MJ780073	
Needle bearing For Murray / Noma snowblowers. Found on models: 826, 1026 and 1032. Size: 3/4" (.750") ID X 1" OD X 3/4" (.750") HT. (Taller version of our 225-466).		

NOMA - AMF / Canadiana / Dynamark NOMA - AMF / Canadiana / Dynamark



Part#	O.E.M	Application
780-580 NEW	579726 579726MA	
<p>Impeller Bearing Housing only For Murray / Noma snowblowers. (Made of Aluminum). Size: 1-1/4" ID X 7/8" Overall Height. (3) 5/16" Mounting holes on 2.35" centers. (Uses our 225-677 Bronze Bushing in many applications).</p>		
225-850	85084	
<p>Bronze flange bushing Fits on Noma & Murray Snowblowers. Size: 7/8" ID X 1-1/8" OD X 5/8" HT. Flange OD: 1-1/2"</p>		
225-851	313887 53836	
<p>Graphite impregnated hex flange bushing. Fits on Noma and Murray Snowblowers Size: 3/4" ID X 7/8" OD (Hexagon) X 11/16" HT with flange; Flange OD: 1-3/16"; 7/8" across the flats.</p>		
225-334	53829	
<p>Bronze flange bushing Fits on Noma and Murray Snowblowers. Size: 1/2" ID X 3/4" OD X 5/8" HT. Flange OD: 1"</p>		
230-025	54837 577023	
<p>Plastic Auger bushing Fits on Noma Snowblowers. Size: 43/64" ID X 1-7/8" W X 3-3/4" L. Bolt holes are 1/4" on 2.932" centres .925" Overall height</p>		
225-852	581730	
<p>Bronze flange bushing Axle bearing on Noma Snowblowers & others. Size: 3/4" ID X 1-1/8" OD X 3/4" HT</p>		
225-150 NEW	53731 53731MA Murray# 53731 Murray# 53731MA Swisher# 53731 Swisher# 53731MA	
<p>Bronze Bushing / Bearing Sleeve For Murray / Noma / Canadiana. Impeller shaft bushing / bearing sleeve. Found on many Sears / Craftsman Dual Stage snowblowers. Models 536-888110 etc. Size: 3/4" ID X 7/8" OD X 3/4" HT.</p>		

Part#	O.E.M	Application
225-078	39980	
<p>Graphite impregnated flange bushing Size: 3/4" ID X 1-1/8" OD X 3/4" HT</p>		
215-565	40195 / 39432 39580 / 54902	
<p>Graphite impregnated flange bushing Size: 3/4" ID X 1-3/8" OD X 3/4" HT. Flange OD: 1-9/16"</p>		
215-145	39979 300793	
<p>Graphite impregnated flange bushing Wheel bushing on many models Size: 3/4" ID X 1-3/8" OD X 5/8" HT</p>		
225-201	43987 48666	
<p>Bearing Retainer Fits on older model Lawnmowers, AMF etc. Size: 5-7/8" L X 2-1/2" W (Use with 225-177 bushing: requires 2 per application)</p>		
125-336	42690 44847	
<p>Rubber fuel tank bushing. For use on many applications. Fits 33/64" diameter fuel tank holes. Size: .356" ID X .615" OD</p>		(Priced Individually) (Sold in multiples of 5)
225-673 NEW	578572 Murray# 585581 MTD# 741-0401 Cub Cadet# 7410401	
<p>Plastic wheel bushing For MTD. Used to reduce wheels from 7/8" to 3/4" inside diameter. Size: 3/4" ID X 7/8" OD X 1" HT</p>		
230-268 NEW	85504	
<p>Bushing with cage assembly For Snowblowers. Bushing ID: 1/2" ID X 3/4" OD. Cage measures: 2-1/2" X 2" W. (Uses our 225-334 bushing - included).</p>		
230-262 NEW	1413 Swisher# 334163	
<p>Bearing with cage assembly For Snowblowers. Fits many manufacturers snowblowers - Murray / Noma / Canadiana, Sears / Craftsman, Swisher etc. Self-Aligning Bronze Bushing ID: 7/16" X 1/2" HT. (2) 5/16-18" threaded mounting holes on 1-3/4" centers</p>		

SCAG

Part#	O.E.M	Application
215-103	48668 48005-04 48005-05	 Tapered roller bearing & race assembly. Fits new style spindles also rear bearing on Riders. Models ST12B,13K,17KA & 18KH. Size: 1" ID X 1-31/32" OD X 19/32" HT (Bearing# L44610 & L44643)
230-060	48102	 Transmission idler pulley bearing on models ST12B, 13K, 17KA and 18KH. Idler bearing on SM48, SM61 and SM72 decks. Size: .669" ID X 1.578" OD X .475" HT (Bearing# 6203-2DRS-LG / 6203-2RS)
230-003	48224	 Spindle bearing On belt drive walk behinds. Also gearbox neutral return bearing on ZTR models. Size: 5/8" ID X 1-3/8" OD X 7/16" HT (Bearing# 99502H / 1623-2RS)
230-086	48101-01 48101-02	 Spindle bearing On old style spindle assemblies. Size: .987" ID X 2.4375" OD X .670" HT (Bearing# 6305-2RS / 6305-RST)
215-212	48193-01 481858	 Wheel bearing Fits Scag belt drive walk-behinds, 5 speed units. Will not fit wheels requiring a 1.984" OD Size: 1.007" ID X 2.002" OD X .671" HT
225-722	48100-01 46082	 Bottom bushing for caster support arm. Also steering shaft bushing for pivot wheel on 12, 13 and 17 Hp Turf Runner models. Size: 7/8" ID X 1-1/8" OD X 1" HT. Flange OD: 1-1/2"
410-294	43278	 Blade Spacer Fits all new Scag commercial mower blades. Size: 5/8" ID X 1-1/2" OD X 1/4" HT (Priced individually) (Sold in multiples of 10)

SCAG continued

Part#	O.E.M	Application
215-163 NEW	43581	 Spanner Bushing / Spacer Size: 1/2" ID X 3/4" OD X 5-7/8" Length.
215-168 NEW	43430	 Spanner Bushing / Spacer Fits turf tiger mowers. Size: 1/2" ID X 5/8" OD X 6" Length.
215-162 NEW	43583	 Spanner Bushing / Spacer Size: 1/2" ID X 3/4" OD X 7-1/2" Length.

SEARS - SEE
AYP / ROPER / SEARS







SIMPLICITY

230-003	1665521	 Spindle bearing Size: 5/8" ID X 1-3/8" OD X 7/16" HT (Bearing# 99502H / 1623-2RS)
230-060	1666292 1705897	 Spindle bearing Size: .669" ID X 1.578" OD X .475" HT (Bearing# 6203-2DRS-LG / 6203-2RS)
230-037	108202 2108202 2108202SM 536986 7013313	 Spindle bearing Size: .750" ID X 1.781" OD X .6075" HT (Bearing# 9504AB / P204RR6)
230-029	118011 1652231 2118011	 Spindle bearing Size: .787" ID X 1.851" OD X .551" HT (Bearing# 6204-2RS)
215-103	170835 2170835	 Tapered roller bearing & race assembly. Size: 1" ID X 1-31/32" OD X 19/32" HT (Bearing# L44610 & L44643)

SIMPLICITY continued

Part#	O.E.M	Application
215-557	156316 2156316	
Wheel bushing graphite impregnated. Fits models 3100, 4200, 5200 & 6500 riders. Size: 3/4" ID X 1-1/8" OD X 5/8" HT Flange: 1.325" OD X .108" HT		







SNAPPER

230-106	1-2304 2-8014 7028014	
Hex shaft bearing For 21" self propelled mowers. Size: 3/8" ID X 1" OD X 5/16" HT		
230-056	7-6504 7076504	
Transmission shaft support bearing Fits older style single belt drive walk-behinds for 32", 36" and 48" variable speed models Size: 5/8" ID X 1-9/16" OD X 1" HT		
230-057	7-6505	
Flange plate Used to hold transmission shaft bearings. Fits variable speed models. Use with our 230-056 bearing Size: 1.477" ID		
230-144	1-8767 46983 7046983	
Wheel arm bearing w/retainer ring Fits 21" self-propelled walk-behinds mowers. Size: .563" ID X 1.375" OD X .437" HT (Bearing# 16222-RS10R / 16222-RSNR)		
215-202	1-0756 7010756 7-9339	
High speed bearing, double sealed. Snapper chain case bearing. Fits McLane and Star Clipper edgers. Sprocket shaft bearing with retainer ring. Fits on many Go-carts and Mini bikes. Fits Snapper 30" two stage large frame snowblowers, series 0, 1, 3, 4, 5 and 6; 25" rear engine riders, series 10, 12, 2, 3, 4, 5 and 9). For bearing without retainer ring order our part# 230-003 Size: 5/8" ID X 1-3/8" OD X 7/16" HT. (Bearing# 499502H / 99502H-2RSNR)		
230-003	7-7324 1-4514 7014514	
Spindle bearing Also gearbox neutral return bearing - some models. Pro gear drive pistol grip series 1, 2, 4 Size: 5/8" ID X 1-3/8" OD X 7/16" HT (Bearing# 99502H / 1623-2RS)		



SNAPPER continued

215-210	1-0943 / 1-0953 / 1-1807 1-2390 / 1-3680 / 1-5474 26693 / 7026693 / 7028722 70953	
Drive disc bearing Fits self-propelled models - heavy duty bearing. Size: 3/4" ID X 1-3/8" OD X 7/16" HT (Bearing# 499502H)		
230-037	5-4073 / 1-0696 1-3313 / 7013313	
Spindle Bearing 30" two stage large frame snowblowers, rear engine riders. Size: .750" ID X 1.781" OD X .6075" HT (Bearing# 9504AB / P204RR6)		
230-029	1-2828 7012828	
Spindle bearing Fits models 60370 and 80499, 54" cut decks. Size: .787" ID X 1.851" OD X .551" HT (Bearing# 6204-2RS)		
230-102	7-9813 4-6555 7046555	
Spindle bearing For hydro gear drive ZTR series 4, 5; 42", 48", 60" deck, mid mount ZTR series 2, 4. Size: .987" ID X 2.045" OD X .591" HT (Bearing# 6205-RS / 6205-2RS) Sealed one side Two pictures shown for reference.		
230-086	7-6510 1-9125 7019125	
Spindle bearing Used on pro gear drive loop and pro hydro loop handle series, pro 8 gear loop, pro gear drive pistol grip series. Size: .987" ID X 2.4375" OD X .670" HT (Bearing# 6305-2RS / 6305-RST)		
215-236	7-7220	
Wheel Bearing Kit. Open cage roller beaing with flanged bushings - fits 6" caster wheels. Size: 5/8" ID X 1-3/8" OD X 1-7/16" bearing cage length or 2-7/16 (between bushing flanges). Overall length with (2) bushings: 2-3/4".		
225-995	1-2296	
Axle bushing - right side. Fits 26" thru 33" cut Riders. Size: 1-1/8" ID X 1-5/8" OD X 1-1/2" HT Flange OD: 1-1/2"		

SNAPPER continued

Part#	O.E.M	Application
225-987	5-0918 7050918	 Axle bushing - left side Fits 26" thru 33" cut Riders. Size: 3/4" ID X 1-3/4" HT X 1.6255" Small OD X 1.750" Large OD
225-722	7-6514 7076514	 Graphite impregnated flange bushing. Fits caster support arms & some steering shafts. Size: 7/8" ID X 1-1/8" OD X 1" HT. Flange OD: 1-1/2"
225-656	1-0694	 Plastic flange bushing Bottom Steering bushing on rear engine Riders. Size: 5/8" ID X 11/16" OD X 23/64" HT. Flange OD: 1"
225-219	1-3321 7013321 / 1-0743 1-1099 / 1-1100	 Plastic flange bushing Tie rod bushing for rear engine Riders. Size: 3/8" ID X 1/2" OD X 3/8" HT. Flange OD: 5/8"
225-227	1-0986 7010986	 Plastic flange bushing King pin bushing, fits rear engine riders. Size: 3/4" ID X 13/16" OD X 9/16" HT. Flange OD: 1-1/4"
225-206	1-1048 7011048	 Shift yoke bushing Fits in shift yoke on rear engine riders. Size: 5/16" ID X 7/8" OD X 3/8" HT. Flange OD: 1"



STIGA (NOMA CANADIANA)

225-109	1134-1875-01	 Front Wheel Bushing Size: 3/4" ID X 1" OD X 1" HT
225-116	1134-9026-01	 Front Wheel Bushing For Stiga (Noma / Canadiana). Includes: (4) wheel bushing in total. (Priced and sold as a set of 4) Size: 3/4" ID X 1" OD X 1" HT



STIHL

Part#	O.E.M	Application
681-125	0000-993-3008 (Oregon# 37431)	 Sprocket Bearing For chain saw models: 08S and Cut-Quik models: TS350 and TS360. Fits our 99-187A7, 99-187B7 etc. NOTE: This bearing will not replace the plastic needle bearing type used on newer models. (Size: 15mm X 18mm X 17mm)
681-134	(Carlton# 37325) (Oregon# 37325)	 Sprocket bearing Fits many chain saw manufacturers drive sprockets. Stihl 009, 010, 011, 012, 021, 023, 024, 025, 026 (PRIOR TO x25809074). NOTE: This bearing will not replace the plastic needle bearing type used on newer models. (Size: 10mm X 13mm X 10mm)
681-126	9512-933-2380 9512-933-2382 (Oregon# 37504)	 Sprocket Bearing Fits STIHL 044, 046, MS440 MS460, 064, 066, MS640, MS660. NOTE: Will also replace the original STIHL (plastic cased needle bearing) in the MS390. (Size: 10mm X 16mm X 12mm)
681-127	(G.b. America Inc.# 101624) (G.b. America Inc.# 121624) (Oregon# 37514)	 Sprocket Bearing Fits Stihl 038, 042, 048 (SPUR ONLY). Fits our 99-192A7 etc. (Size: 12mm X 16mm X 24mm)
593-102	9503-003-0310	 Crankshaft bearing - (flywheel side). Fits chain saw model: 041. Size: 15mm ID X 32mm OD X 9mm HT (Bearing# 6002/C3) Open both sides
593-103	9503-003-0440 9503-003-0450	 Crankshaft bearing (flywheel side). Fits Stihl chain saw models: 038, 038 Super, 038 Magnum, 051, 075 and TS-510 and TS-400 (recoil side) cut quik saws. Fits ICS models 613GC, 633GC and 680GC; replaces ICS# 73209. Size: 17mm ID X 40mm OD X 12mm HT. (Bearing# 6203/C3) Open both sides
592-109	9503-003-0540	 Crankshaft bearing - (clutch side) Fits chain saw models: 051 and 075. Size: 20mm ID X 47mm OD X 14mm HT. (Bearing# 6204/C3) Open both sides

STIHL continued

Part#	O.E.M	Application
592-106	9503-003-0340 9503-003-0341 Husky# 738 22 02-25	 Crankshaft Bearing - Fits models: 08S, 038, 038 Super, 038 Magnum and 041 - (clutch side). Cut-Quik models: TS350 & TS360 - (clutch & flywheel side); also fits Cut-Quik model: TS400. Fits models 034, 036, 044, 046, MS360, MS440 and MS460 (flywheel side). Size: 15mm (37/64") ID X 35mm (1-3/8") OD X 11mm (7/16") HT (Bearing# 6202 - open both sides)
591-110	9512-003-3440	 Piston needle bearing Fits Chain Saw models 051 & 075. (While Quantities Last)

TECUMSEH

225-474	780086 780086A	 Needle bearing Fits all 700 series transmission input shafts. Also fits 800 and 900 series transaxles. Size: 5/8" ID X 13/16" OD X 1/2" HT
225-466	530105	 Needle bearing Fits on most 600 and 2300 model found on the Tecumseh peerless transmissions. Size: 3/4" ID X 1" OD X 1/2" HT (While Quantities Last)
125-336	33679	 Fuel tank bushing - rubber. Fits 33/64" diameter tank holes. Size: .615" ID X .356" (Priced individually) (Sold in multiples of 5)

TORO / WHEEL HORSE









780-582 NEW	201730	 Axle Bearing / Wheel Mount Support for Toro snowblowers. Found on many 524, 624, 724 and 824 models. Bronze Bushing measures: 7/8" ID X 1-1/8" OD X 3/4" HT. Aluminum Plate measures: 3-1/4" L X 1-3/4" W X 1/4" Thick. (2) 3/8" ID mounting holes on 2-5/16" centers.
------------------------------	--------	--

TORO / WHEEL HORSE

Part#	O.E.M	Application
215-227 NEW	Wheel Bearing Kit	 Fits Toro wheel 68-8970 front caster wheel assembly. Fits Toro mid size mower 36", 37", 44", 52" & 62" cut decks, models 30136, 30137, 30144, 30152, 30162. Includes: (1) 215-170 spanner bushing, (1) 215-240 roller cage bearing and (2) 225-678 retainer bushings. Overall ID: 1/2", Overall OD: 1-3/8", Overall Length: 3-11/32" .
215-240 NEW	62-5570	 Roller Cage Wheel Bearing ONLY. Used on Toro 68-8970 front caster wheel assembly. Size: 3/4" ID X 1-1/2" OD X 1-11/16" Length.
215-170 NEW	68-8980	 Spanner Bushing / Spacer Fits Toro mid size mower 36", 37", 44", 52" & 62" cut decks. Size: 1/2" ID X 3/4" OD X 3-11/32" Length.
225-678	62-5580	 Graphite impregnated flange bushing. Used on Toro 68-8970 front caster wheel assembly Size: 3/4" ID X 1-3/8" OD X 5/8" HT. Flange OD: 1-1/2"
215-095	254-78 254-79	 Tapered roller bearing & race assembly. Fits on Roughmaster, Spartan, Reelmaster & Greensmaster Size: 3/4" ID X 1-25/32" OD X 21/32" HT (Bearing# LM11949 & LM11910)
215-103	45-8530 254-94 254-95	 Tapered roller bearing & race assembly. Fits on Reelmaster models 223S & 5100D and Greenmaster 3, 300, 3000, 3100. Size: 1" ID X 1.988" OD X .43" HT (Bearing# L44610 & L44643)
230-185	47-1490	 Rear axle bearing Fits rear engine models 725, 832, 1132 and 1232. Size: 3/4" ID X 2-1/32" OD X 1-1/16" HT (Bearing# SB205-12)

TORO / WHEEL HORSE

TORO / WHEEL HORSE

Part#	O.E.M	Application
230-250	251-224	
<p>Axle bearing - Snowblowers Models 310-230 thru 310-960 Snowblowers. Size: 7/8" ID X 2-1/32" OD X 1-1/16" HT (Bearing# SB205-14)</p>		
230-062	52-2450	
<p>Wheel bearing Fits all 21" commercial mowers. Size: 1/2" ID X 1.125" OD X .3125" HT (Bearing# 9R8). Sealed one side. Two pictures shown for reference.</p>		
215-210	25-1210 110513 47-1490	
<p>Wheel bearing - heavy duty (For open back race see our 215-079). Size: 3/4" ID X 1-3/8" OD X 7/16" HT. Sealed both side.</p>		
230-060	1001048 / 109966 1120423 / 387820	
<p>Snowblower bearing Fits models S-200, S-620, CCR2000 and CR20. Size: .669" ID X 1.578" OD X .475" HT (Bearing# 6203-2DRS-LG)</p>		
230-052	37-0200 106084 106085	
<p>Spindle bearing Size: 3/4" ID X 1-9/16" OD X 15/32" HT (Bearing# 6203-RS3/4)</p>		
230-045	101480	
<p>Spindle bearing Size: 3/4" ID X 1-5/8" OD X 1/2" HT (Bearing# 1630-2RS3/4)</p>		
230-300	251-207	
<p>Snowblower Input Shaft Support bearing. Fits models 824 and 932. Size: 3/4" ID X 1-3/4" OD X 1/2" HT (Bearing# 1635-2RS / SCO493LU)</p>		
230-029	251-8 251-297 251-318 112-0377	
<p>Spindle bearing Size: .787" ID X 1.851" OD X .551" HT (Bearing# 6204-2RS)</p>		

Part#	O.E.M	Application
230-037	106947 109842 251351 310530	
<p>Spindle bearing Size: .750" ID X 1.781" OD X .6075" HT (Bearing# 9504AB / P204RR6)</p>		
215-212	251-299	
<p>Wheel bearing For pre 1987 commercial mowers. The year is identified by the first digit of the serial # Size: 1.007" ID X 2.002" OD X .671" HT</p>		
230-102	251-257 113514	
<p>Spindle bearing Fits 50" & 60" cut side discharge mowers, also fits 1977 and older Groundsmaster. Size: .9843" ID X 2.0472" OD X .5906" HT (Bearing# 6205RS) Sealed one side Two pictures shown for reference.</p>		
230-069	108-9017 934-237	
<p>NEW Bearing Fits John Deere 600 series Quik-Trak, 600, 700, Z800 and Z900 Z-Trak mowers, also found on Toro GroundsMaster 300 Series, GroundsMaster: 455D, 580D, 3000, 3000D, 3280D, 3320, 3500D, 3505D, 4000D, 4100D, 4500D & 4700D. Size: .630" ID X 1.780" OD X .735" overall HT. (Bearing# SX164518CL8) Two pictures shown for reference.</p>		
230-078	103119	
<p>Deck bearing / Spindle shaft For Toro / Wheel Horse. Spindle shaft OD: 3/4", Overall Length: 4-1/2" Barrel OD: 1-1/2" X 2" Long. (Bearing# 1630-2RS)</p>		
230-409	75-1290	
<p>Deck bearing for double pulley assembly. Can be used on Toro reel mower models: 5200 and 5400D. Size: 30mm barrel diameter X 5/8" shaft diameter X 1-9/16" long, Overall Length: 3-1/8". (Reference#s GR 3200, Roller Assy 94-8150 and Roller kit# 107-1592).</p>		

TORO / WHEEL HORSE

TROY BILT

Part#	O.E.M	Application
225-896	63-3450 26-6100 12-8789	 Spherical bushing Fits impeller shafts on models 524 thru 824. Size: 7/8" ID X 1-45/64" OD X 1-1/4" HT
225-870	20-1010	 Spherical bushing Fits impeller shafts on models 524 thru 824. Size: 7/8" ID X 1-7/8" OD X 1-1/8" HT
225-888	20-0980	 Spherical bushing Size: 1" ID X 1-45/64" OD X 1-3/16" HT
225-900	12-8789 26-6100 63-3450	 Spherical bushing with plates (While Quantities Last) For Toro / Wheel Horse snowblowers. Fits impeller shafts on models 524 thru 824. Size: 7/8" ID X 1-45/64" OD X 1-1/4" HT (Same as our 225-896 but includes plates)
225-676	256-205	 Bronze flange bushing Size: 7/8" ID X 1" OD X 3/4" HT. Flange OD: 1-1/4"
225-677	256-237	 Bronze bushing Size: 1" ID X 1-1/4" OD X 1" HT
225-476	28-9290 94-1291	 Caster Bushing Fits Groundsmaster 52, 62, 217, 220, 300, 500 with 72" deck, 1977 and newer, commercial mid-size mowers with 36", 37", 44", 52" and 62" cut decks Size: 1" ID X 1-1/4" OD X 1" HT
230-700	51-4270 Bobcat# 38213 Encore# 363292	 Bearing with cage assembly. Flange bearing fit Bobcat, Encore and Toro. Found on mid-size walk behind models with Peerless transmissions. Two 9/32" mounting holes on 2-1/2" center to center. Size: 5/8" ID X 3-1/4" OD X 3/4" HT.

Part#	O.E.M	Application
215-202	1185169 / 1185436 1701132 / 1820278 9410155 / GW1185169 GW1793	 Bearing with retainer ring Size: 5/8" ID X 1-3/8" OD X 7/16" HT (Bearing# 499502H)
230-029	1728255 1185121	 Bearing Size: .787" ID X 1.851" OD X .551" HT (Bearing# 6204-2RS)
230-037	1185828 1185574P	 Bearing Fits models 14000, 30042SR, 42" S.D. Center mower; 14001, 51048SR, 48" S.D. Mower; 14002, 42" R.D. Center mount. Size: .750" ID X 1.781" OD X .6075" HT (Bearing# 6204-2RS / P204RR6)
215-015	11522 GW-11522	 Tapered roller bearing & race assembly. For tillers. Size: 1-1/4" ID X 2-21/64" OD X 21/32" HT (Bearing# LM67048 and LM67010)
230-060	1120502 1185064 941-0124	 Spindle bearing Size: .669" ID X 1.578" OD X .475" HT (Bearing# 6203-2RS)
230-003	1185169	 Spindle bearing Fits lawn edgers. Size: 5/8" ID X 1-3/8" OD X 7/16" HT (Bearing# 99502H)
215-565	1720327 1750341 1750341099	 Wheel bushing Size: 3/4" ID X 1-3/8" OD X 3/4" HT



VELKE

Part#	O.E.M	Application
215-234	VKRLBRG	 <p>Wheel Bearing only Fits Velke wheel assemblies. Size: 25/32" ID X 1-11/32" OD X 2-45/64" L</p>
215-232	VKBRGKIT	 <p>Wheel Bearing Kit Same bearing as above Includes: bearing, (1) spaner bushing & (2) bushings. Size: 25/32" ID X 1-11/32" OD X 2-45/64" L</p>
215-184	Fits our 175-125 wheel assembly.	 <p>Wheel Bearing Kit Fits our 175-125 Wheel Assembly and Exmark Wheel# 1-3322154. Also fits Gravely 45205 front caster wheels. Found on 40" and 50" cut mowers. Includes: (1) Roller Cage Bearing, Size: 3/4" ID X 1-11/32" OD X 2-7/16" Overall Length, (2) Retainer Bushings, Size: 3/4" ID X 1-3/8" OD X Flange OD: 1-1/2", Flange Height: 1/8" X Overall Height: 3/8", (1) Spanner Bushing, Size: 1/2" ID X 3/4" OD X 3-5/16" Overall Length. (Fits our 175-125 wheel assembly).</p>

YAZOO

230-003	204-020	 <p>Idler bearing Fits YR60 and 76 models. Size: 5/8" ID X 1-3/8" OD X 7/16" HT (Bearing# 99502H / 1623-2RS)</p>
230-011	204-019	 <p>Spindle bearing Size: .625" ID X 1.575" OD X .475" HT (Bearing# 6203-2RS5/8)</p>
230-037	204-060	 <p>Spindle bearing Fits YR60 and 76 models. Size: .750" ID X 1.781" OD X .6075" HT (Bearing# 9504AB / P204RR6)</p>



BEARING QUICK REFERENCE

Part#	O.E.M	Application
TYPE 1		
 		
230-106	.375" 1.000"	.312" XXX
225-268	.394" 1.181"	.454" 6200ZZ
230-600	10mm 26mm	8mm 6000-2RS
230-620	10mm 30mm	9mm 6200-2RS
230-630	10mm 35mm	11mm 6300-2RS
230-006	12mm 28mm	8mm 6001-2RS
230-621	12mm 32mm	10mm 6201-2RS
230-631	12mm 37mm	12mm 6301-2RS
230-062	.500" 1.125"	.312" 9R8
230-276	.500" 1.375"	.437" 1621-2RS
230-241	.500" 1.375"	.500"
592-106	.578" 1.375"	.437" 6202
230-134	15mm 32mm	9mm 6002-2RS
593-102	15mm 32mm	9mm 6002/C3
230-622	15mm 35mm	11mm 6202-2RS
230-632	15mm 42mm	13mm 6302-2RS
230-003	5/8" 1-3/8"	7/16" 99502H / 1623-2RS
230-011	.625" 1.575"	.475" 6203-2DRS-LG-10
230-069	.630 1.780	.735 SX164518CL8
230-060	.669" 1.575"	.471" 6203-2RS
230-603	17mm 35mm	10mm 6003-2RS
593-103	17mm 40mm	12mm 6203/C3
230-633	17mm 47mm	14mm 6303-2RS
230-052	.750" 1-9/16"	15/32" 6203-2RS3/4
230-045	.750" 1.625"	.500" 1630-2RS3/4
230-300	.750" 1.750"	.500" 16352RS / SCOU493LU
230-037	.750" 1.781"	.6075" 9504AB / 9504LAB & P204RR6A4362
230-114	.750" 2.000"	.562" 1638-2RS
230-029	.787" 1.851"	.551" 6204-2RS
230-140	20mm 42mm	12mm 6004-2RS
592-109	20mm 47mm	14mm 6204/C3
230-634	20mm 52mm	15mm 6304-2RS
215-214	.875" 1.750"	.500" 8186
230-267	.875" 2.000"	.562" XXX
230-034	.875" 2.000"	.562" XXX
230-605	25mm 47mm	12mm 6005-2RS
230-086	.987" 2.4375"	.670" 6305-2RS / 6305-RST
230-102	.987" 2.045"	.591" 6205RS
230-032	1.000" 2.000"	.562" 1614-2RS
230-036	1.000" 2.000"	.560" 8446RS(Dome)
230-233	1.00" 2.045"	.703" CS203ASSY / RA100RR7E8728
230-087	1.117" 2.166"	1.257"
230-038	1.125" 2.187"	.625" 8276-1RS
230-606	30mm 55mm	13mm 6006-2RS
230-626	1.181" 2.440"	.629 6206-2RS
230-636	30mm 72mm	19mm 6306-2RS
230-607	35mm 62mm	14mm 6007-2RS
230-627	35mm 72mm	17mm 6207-2RS

BEARING QUICK REFERENCE

Part#	ID	OD	Height	Reference
-------	----	----	--------	-----------





TYPE 1 continued

				
230-608	40mm	68mm	15mm	6208-2RS
230-628	40mm	80mm	18mm	6208-2RS

TYPE 2

				
215-236	5/8"	1-3/8"	1-7/16"	(Bearing kit)
215-255	5/8"	1-3/8"	1-7/16"	
215-238	.658"	1.337"	3.128"	
215-234	25/32"	1-11/32"	2-45/64"	(Velke)
215-232	25/32"	1-11/32"	2-45/64"	(Bearing kit)
215-184	3/4"	1-1/4"	2-1/2"	(Bearing kit)
215-240	1/2"	1-1/2"	1-11/16"	
215-250	49/64"	1-1/4"		



TYPE 3

				
215-095	3/4"	1-25/32"	21/32"	LM11949 / LM11910
215-103	1"	1-31/32"	19/32"	L44610 / L44643
215-015	1-1/4"	2-21/64"	21/32"	LM67048 / LM67010

TYPE 4

				
230-409	See John Deere & Toro Headings			
230-078	See Toro / Wheel Horse Heading			



TYPE 5

				
215-004	7/16"	1-1/8"	XX	
215-012	1/2"	1-1/8"	XX	
215-020	1/2"	1-3/8"	XX	
230-088	1/2"	1-3/8"	1"	
215-053	9/16"	1-3/8"	XX	

BEARING QUICK REFERENCE

Part#	ID	OD	Height	Reference
-------	----	----	--------	-----------

TYPE 5 continued

				
215-038	5/8"	1-3/8"	XX	
215-061	5/8"	1-3/8"	XX	
215-247	5/8"	1-3/8"	9/16"	841-9RS
215-046	3/4"	1-3/8"	XX	
215-079	3/4"	1-3/8"	.467"	
215-210	3/4"	1-3/8"	7/16"	
215-212	1.007"	2.002"	.671"	

TYPE 6

				
230-056	5/8"	1-9/16"	1"	SB202-10
230-002	3/4"	1.850"	1-3/16"	SA204-12
230-185	3/4"	2-1/32"	1-1/16"	SB205-12
230-126	1"	2.046"	1-3/16"	SA205-16 CSA205-16 / RA100RR
230-260	1"	2.046"	1-3/4"	HC205-16

TYPE 7

				
230-270	9/16"	1-3/8"	7/16"	1622-2RS
230-144	.563"	1.375"	.437"	16222-RS10R
230-049	5/8"	1-9/16"	15/32"	6203LU
215-202	5/8"	1-3/8"	7/16"	499502H
230-007	21/32"	1-3/8"	7/16"	XXX
230-274	.669"	1.574"	.471"	6203ZZ / 6203-2Z
230-094	.787"	1.850"	.551"	6204NSL / 6204RSNR
215-200	.984"	2.046"	0.671"	6205
230-260	1"	2.046"	1-3/4"	HC205-16

TYPE 8

				
225-036	3/8"	9/16"	.310"	XXX
225-104	9/16"	3/4"	9/16"	XXX
225-474	5/8"	13/16"	1/2"	XXX
225-466	3/4"	1"	1/2"	XXX
225-470	3/4"	1"	3/4"	
225-375	7/8"	1-1/8"	3/4"	FC65771
225-102	1-1/8"	1-3/8"	5/8"	XXX
225-615	1-1/4"	1-1/2"	1"	XXX



BUSHING QUICK REFERENCE

BUSHING QUICK REFERENCE

Part#	ID	OD	Height	FlangeOD	Material
-------	----	----	--------	----------	----------

Part#	ID	OD	Height	FlangeOD	Material
-------	----	----	--------	----------	----------



TYPE 1

					
225-847	3/8"	1/2"	3/8"	5/8"	Plastic
225-219	3/8"	1/2"	3/8"	5/8"	Nylon
215-809	3/8"	.669"			
215-813	3/8"	.669"			
215-817	3/8"	.669"			
215-160	1/2"	5/8"	5/8"		Nylon
215-805	1/2"	.669"			
215-801	1/2"	.669"			
215-848	1/2"	.669"			
225-276	1/2"	3/4"	3/4"	XX	Bronze
225-334	1/2"	3/4"	5/8"	1"	Bronze
285-153	1/2"	1-1/8"	1/4"		Nylon
125-336	.615"		.356"		Rubber
225-822	5/8"	3/4"	1/2"	7/8"	Bronze
225-045	5/8"	7/8"	5/8"	1-1/8"	Bronze
225-169	5/8"	13/16"	7/8"	1-1/8"	Nylon
225-750	5/8"	13/16"	1"	1-1/8"	Nylon
225-110	5/8"	3/4"	3/4"	1-1/8"	Bronze
225-300	5/8"	3/4"	1"	1-1/4"	Bronze
225-656	5/8"	11/16"	23/64"	1"	Plastic
225-056	5/8"	13/16"	1"	1-1/4"	
225-240	5/8"	31/32"	1"	1-1/4"	Plastic
225-217	3/4"	13/16"	9/16"	1-1/4"	Plastic
225-227	3/4"	13/16"	9/16"	1-1/4"	Plastic
225-854	3/4"	1"	5/8"	XX	Bronze
225-173	3/4"	1"	1-15/16"	1-1/8"	Graphite
225-167	3/4"	1"	5/8"	1-1/2"	Bronze
225-144	3/4"	1"	3/4"	1-1/4"	Plastic
225-116	3/4"	1"	1"	XX	Graphite
225-170	3/4"	1"	1"	1-1/8"	Bronze
225-057	3/4"	1"	1-3/8"		
225-238	3/4"	1-1/16"	15/16"	1-3/8"	Plastic
225-852	3/4"	1-1/8"	3/4"	XX	Bronze
225-146	3/4"	1-3/8"	1"	1-1/2"	Plastic
225-987	3/4"		1-3/4"	1.750"	
225-160	.754"	1"	.925"	1-1/4"	
225-754	.754"	.940"	.980"	XX	Plastic
225-676	7/8"	1"	3/4"	1-1/4"	Bronze
225-862	7/8"	1"	5/8"	XX	Bronze
225-850	7/8"	1-1/8"	5/8"	1-1/2"	Bronze
225-722	7/8"	1-1/8"	1"	1-1/2"	Graphite
225-674	7/8"	1-1/8"	1"		
225-984	15/16"	1-1/4"	11/16"	1-5/8"	Nylon
225-839	1"	1-1/8"	5/8"	1-1/2"	Bronze
225-714	1"	1-1/4"	3/4"	1-5/8"	Bronze
225-476	1"	1-1/4"	1"	XX	XXXX
225-320	1"	1-1/4"	1"	1-3/4"	XXXX
225-175	1"	1-1/4"	1"	1-1/2"	Plastic
225-995	1-1/8"	1-5/8"	1-1/2"	1-1/2"	



TYPE 2

					
225-086	5/8"	1-1/8"	3/4"		Graphite
215-557	3/4"	1-1/8"	5/8"		Graphite



TYPE 3

					
225-122	1/2"	11/16"	19/32"	XX	Plastic
225-532	5/8"	7/8"	5/8"	1-1/8"	Plastic
225-128	5/8"	7/8"	5/8"	1-1/8"	Bronze
225-129	5/8"	7/8"	1/4"	1-1/8"	Graphite
225-851	3/4"	7/8"	11/16"	1-3/16"	Graphite
225-534	3/4"	1-1/16"	3/4"	1-1/4"	Plastic
225-538	3/4"	1-1/4"	3/4"	1-3/8"	Bronze

TYPE 4

					
225-136	5/8"	1-3/8"	17/32"	1-1/2"	Graphite
225-075	3/4"	1"	3/4"	1-3/8"	Graphite
225-235	3/4"	1-1/4"	3/4"	1-3/8"	Plastic
225-314	3/4"	1-1/2"	3/4"	1-3/4"	Plastic
225-280	1"	1-1/2"	3/4"	1-3/4"	Graphite

TYPE 5

					
225-828	1/2"	5/8"	5/8"	3/4"	Bronze
225-823	1/2"	3/4"	3/4"	1"	Bronze
225-318	5/8"	3/4"	3/4"	1"	Bronze
225-825	3/4"	1"	3/4"	1-1/4"	Bronze
225-826	1"	1-1/8"	5/8"	1-1/2"	Bronze

BUSHING QUICK REFERENCE

Part#	ID	OD	Height	FlangeOD	Material
TYPE 6					
					
215-145	3/4"	1-3/8"	5/8"		Graphite
225-678	3/4"	1-3/8"	5/8"	(1) side has a flat FOR	Graphite
225-078	3/4"	1-1/8"	3/4"		Graphite
215-565	3/4"	1-3/8"	3/4"	(2) see Type 4	Graphite
225-006	3/4"	1-3/8"	1"		Graphite
225-730	3/4"	1-1/2"			
225-704	5/8"	1-1/2"			

TYPE 7

					
215-152	5/8"	13/16"	1-1/4"		
225-896	7/8"	1-45/64"	1-1/4"		Graphite / Bronze
225-870	7/8"	1-7/8"	1-1/8"		Graphite / Bronze
225-888	1"	1-45/64"	1-3/16"		Graphite / Bronze

TYPE 8

					
285-874	3/4"	1"	1-3/4"		Steel

TYPE 9

					
215-178	3/8"	1/2"	2-1/4"		Steel
215-186	7/16"	1/2"	2-1/4"		Steel
215-194	1/2"	5/8"	3"		Steel
215-168	1/2"	5/8"	6"		
215-161	1/2"	3/4"	4-5/8"		Steel
215-170	1/2"	3/4"	3-11/32"		
215-163	1/2"	3/4"	5-7/8"		
215-162	1/2"	3/4"	7-1/2"		
285-171	5/8"	7/8"	1-3/4"		Graphite
285-742	5/8"	13/16"	1/2"		Graphite
225-282	.630"	.720"	.720"		Bronze
225-150	3/4"	7/8"	3/4"		Bronze
225-673	3/4"	7/8"	1"		Plastic
225-572	3/4"	1"	1"		Bronze
225-706	7/8"	1-1/8"	1-1/4"		Bronze
225-677	1"	1-1/4"	1"		Bronze

BUSHING QUICK REFERENCE

Part#	ID	OD	Height	FlangeOD	Material
TYPE 10					
					
225-284	1/2"	7/8"	7/8"		Nylon / Bronze

TYPE 11

					
225-206	5/16"	7/8"	3/8"	1"	Plastic
225-154	5/8"	1-3/8"	45/64"		Plastic
225-152	7/8"	1-3/8"	1"		Plastic

TYPE 12

					
225-109	3/4"	1"	1"		Graphite

TYPE 13

					
225-319	5/8"	.900"	7/8"	1.08"	Plastic
225-148	3/4"	7/8"	11/16"		Plastic

TYPE 15

					
225-009	3/8"	17/32"	15/32"	7/8"	Plastic
225-132	3/8"	1/2"	3/8"	5/8"	Plastic
225-230	1/2"	3/4"	7/16"	1"	Plastic
225-745	3/4"	13/16"	25/32"	1-1/8"	
225-536	13/16	7/8"	5/8"	1-1/16"	Plastic

TYPE 16

					
410-308	5/8"	1"	1/4"		Graphite
410-294	5/8"	1-1/2"	1/4"		
285-957	3/4"	1-1/4"	1/4"		Graphite